



UES

POWER

2024 EYLÜL FİYAT LİSTESİ

İÇİNDEKİLER

ASTRONOMİK ZAMAN RÖLESİ.....	3
ENDÜKTİF YÜK SÜRÜCÜLERİ.....	6
TRİSTÖRLÜ KONDANSATÖR ANAHTARLAMA MODÜLÜ.....	6
GPRS MODEM.....	6
ENERJİ ANALİZÖRLERİ.....	7
MULTİMETRE.....	7
KOMPANZASYON KONTAKTÖRLERİ.....	7
AKIM TRAFOLARI.....	8-10
HARMONİK FİLTRE.....	11
ŞÖNT REAKTÖRÜ.....	12
SİLİNDİRİK ALÜMİNYUM TÜP A.G. GÜÇ KONDANSATÖRLERİ.....	13
DAİMİ DEVRE KONDANSATÖRLERİ.....	14
MOTOR İLK HAREKET (START) KONDANSATÖRLERİ.....	14
BUTON SERİSİ VE BUTON AKSESUARLARI.....	14-17
SİNYAL LAMBALARI VE BUZZER.....	18
PANO SARF MALZEMELERİ.....	19
STANDART BEYAZ KABLO BAĞLARI.....	20
KABLO TOPLAMA SPİLARALLERİ-YAPIŞKAN KROŞELER.....	21
FANLAR VE FAN FİLTRELERİ.....	22
ISI İLE DARALAN MAKARONLAR.....	23-24
ISI BÜZÜŞMELİ EK MUFLAR.....	25-27
KLEMENSLER.....	28
MESNET İZOLATÖRLERİ.....	29-30
TARAK İZOLATÖLERİ.....	31-35
SIKMALI KABLO PABUÇLARI.....	36-37
KABLO YÜKSÜKLERİ.....	38-40
PANO TOPRAKLAMA KLEMENSLERİ.....	41-42
DAĞITIM ÜNİTELERİ.....	43-46
BARALAR.....	47
ORTA GERİLİM SİGORTALARI.....	48
HAT KLEMENSLERİ.....	49
İZOLASYON KAPAMALARI.....	50
PARATONER VE İŞ GÜVENLİĞİ EKİPMANLARI.....	51-54

AZR-01 ASTRONOMİK ZAMAN RÖLESİ



- Astro ve yıllık program
- 10 yıllık güç rezervi (lityum pil)
- 52 program (AZR-02) ve 100 program (AZR-01)
- Ön panelin kapatılabilir kapağı, 4 tuşla kolay ayarlama
- Otomatik yaz/kış saati geçişi
- Arkadan aydınlatmalı LCD ekran (kapatılabilir)

- Tatil modu
- Rastgele mod
- Tek (AZR-02) ve çift (AZR-01) kanal
- Hafta içi günlerin otomatik aktarımı
- 24-264V AC/DC giriş beslemesi
- Otomat rayına monte edilebilir

Ürün Modeli	Fiyat / TL	Ürün Açıklaması	16A	Astronomik	Program Sayısı	Tatil Kilidi	1 Röle Çıkışı	2 Röle Çıkışı	85-265 VAC	190-260 VAC	DIN Kutu	Adet / Koli
AZR-01	2790,00	Astronomik Zaman Rölesi	*	*	100	*	*	*	*	*	*	*

AZR-01 çok fonksiyonlu zaman rölesi, otomatik ve manuel sistemlerin zamana göre kontak açıp kapatma fonksiyonlarının gerçekleştirilmesi içindir. Ayarlanan coğrafi bölge ve saat diliminde gün doğumu ve gün batımı saatlerini fotoselli sensör kullanmadan hesaplar. Elektrik beslemesi kesildiğinde gerçek zamanlı saati ve tüm ayarları koruyabilecek dahili bir pil bulunmaktadır.

POWER SERİSİ REAKTİF GÜÇ KONTROL RÖLELERİ

Stok Kodu	Model	Fiyat \$	Minimum Ölçüm Akımı(mA)	Kademe Sayısı	Şönt Reaktör	Cepten(android) Uzaktan İzleme	Uzaktan Ayar Değiştirme	63. Harmoniğe Kadar Ölçüm	31. Harmoniğe Kadar Ölçüm	Otomatik Setup	Şifre Koruma	İç Isı Ölçüsü	Haberleşme	Ekran Tipi	Gerçek Zamanlı Saat	Kademe Ömürlerini Koruma	Yanlış Bağlantı Düzeltme	SVC/TCR Çıkış	Tristör Tetikleme Uygun	Enerji Sayaçları	Koli Adeti	
PWR 12M	Power 12 M Monofaze	220 \$	20	12										LCD								6
PWR 12MH	Power 12 MH Monofaze	230 \$	20	12										LCD								6
PWR 15K	Power 15 K	270 \$	20	15										LCD								6
PWR 18K	Power 18 K	320 \$	5	18										LCD								6
PWR 18 KS	Power 18 KS	389 \$	5	18										LCD								6
PWR 15 SVC	Power 15 SVC	350 \$	5	12										LCD								6
PWR 15 SVCH	Power 15 SVC/H	385 \$	5	12										LCD								6
PWR 18 SVCH	Power 18 SVC	448 \$	5	15										LCD								6
PWR 18 TSC	Power 18 TSC	480 \$	5	18										LCD								6
PWR 24 K	Power 24 K	475 \$	5	24										LCD								6
PWR 24 KS	Power 24 KS	490 \$	5	24										LCD								6
PWR 27 SVCH	Power 27 SVC/H	465 \$	5	24										LCD								6
PWR 15 SVCHOG	Power 15 SVC/H OG	450 \$	5	12										LCD								6
PWR 18 SVCHOG	Power 18 SVC/H OG	480 \$	5	18										LCD								6
PWR 27 SVCHOG	Power 27 SVC/H OG	510 \$	5	24										LCD								6
PWR 27 SVCHCOG	Power 27 SVC/HC OG	640 \$	5	24										LCD								6



YENİ

RPC SERİSİ REAKTİF GÜÇ KONTROL RÖLELERİ

Stok Kodu	Model	Fiyat \$	Minimum Ölçüm Akımı(mA)	Kademe Sayısı	Şönt Reaktör	Cepten(android) Uzaktan İzleme	Uzaktan Ayar Değiştirme	63. Harmoniğe Kadar Ölçüm	31. Harmoniğe Kadar Ölçüm	Otomatik Setup	Şifre Koruma	İç Isı Ölçüsü	Haberleşme	Ekran Tipi	Gerçek Zamanlı Saat	Kademe Ömürlerini Koruma	Yanlış Bağlantı Düzeltme	SVC/TCR Çıkış	Tristör Tetiklemeye Uygun	Enerji Sayaçları	Koli Adeti	
RPC 18 SVC	RPC 18+3 SVC	305 \$	15	18	•	•	•	•	•	•	•	•	•	K-LCD	•	•	•	•	•	•	•	6
RPC 15 SVC	RPC 15+3 SVC	290 \$	15	15	•	•	•	•	•	•	•	•	•	K-LCD	•	•	•	•	•	•	•	6
RPC 12 SVC	RPC 12+3 SVC	275 \$	15	12	•	•	•	•	•	•	•	•	•	K-LCD	•	•	•	•	•	•	•	6
RPC 18K	RPC 18K	275 \$	30	18	•	•	•	•	•	•	•	•	•	K-LCD	•	•	•	•	•	•	•	6
RPC 15K	RPC 15K	255 \$	30	15	•	•	•	•	•	•	•	•	•	K-LCD	•	•	•	•	•	•	•	6
RPC 12K	RPC 12K	240 \$	30	12	•	•	•	•	•	•	•	•	•	K-LCD	•	•	•	•	•	•	•	6



Power RCP serisi reaktif güç kontrol röle ailesi, üç fazlı veya monofaze, orta gerilimde veya alçak gerilimde, dengeli veya dengesiz yüklerde, normal değişken yüklerde veya hızlı değişken yüklerde, SVC gereken yerlerde ve benzeri her türlü kompanzasyon gereksinimlerine çözüm için geliştirilmiştir. Power RCP 18-SVC bu ailenin en karmaşık sistemler için geliştirilen yeni nesil SVC rölesidir. 12-15-18 kontak çıkışına ilave 3 adet reaktör tetikleyici çıkışa sahiptir. Reaktör tetikleyici çıkışa bağlanan Power tristör sürücü modülleri ile 3 adet reaktörü binlerce dilime bölerek mükemmel hassasiyette kompanzasyon yapar. Bütün işlemler 20 ms hızlı ölçümler ile yapılır.

Power RCP ve Power sürücü modülleri kusursuz uyum içinde çalışır. Kullanıcıya 5 farklı SVC modu sunulur. Örneğin SVC sistemi, sadece

kapasitif yükte veya sadece günlük cezada iken devreye girebilir. Normal kademelerle senkron veya asenkron çalışabilir. Senkron çalışma normal kademelerle eş-kompanzasyon yapmak demektir. Asenkron çalışma ise, normal kademelerden arda kalımı temizlemek demektir. Daha detaylı ayarlar bölümünde anlatılmıştır.

Power RCP ailesi geliştirilirken, kullanıcıların ihtiyacı olan her özellik düşünülerek; bütün aile standart sunulan üstün özellik ve ayrıcalıklarla donatılmıştır. Opsiyonel olarak her modelin, tam işlevli haberleşme portu bulunur. Haberleşmeli ürünlerde, eksiksiz olarak her türlü bilgi okunup, yazılıp kumanda edilebilir yapıdadır.

ENDÜKTİF YÜK SÜRÜCÜLERİ MODÜLLERİ

Stok Kodu	Model	Fiyat \$	Koli Adeti
PWR 5ES	Power 5 ES Endüktif Yük Sürücü 3X1.6 kVAr 230 VAC	275 \$	1
PWR 10ES	Power 10 ES Endüktif Yük Sürücü 3X3.5 kVAr 230 VAC	355 \$	1
PWR 20ES	Power 20 ES Endüktif Yük Sürücü 3X6 kVAr 230 VAC	435 \$	1
PWR 50ES	Power 50 ES Endüktif Yük Sürücü 3X15 kVAr 230 VAC	575 \$	1

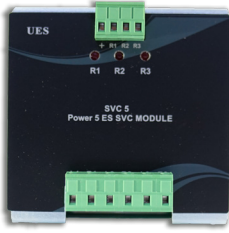

TRİSTÖRLÜ KONDANSATÖR ANAHTARLAMA MODÜLÜ

Stok Kodu	Model	Fiyat \$	Güçü (kVAr)	Gerilimi (V)	Koli Adeti
PWR FAST 125	Power Fast 12,5 450 VAC	400 \$	10	400	1
PWR FAST 25	Power Fast 25 450 VAC	415 \$	25	400	1
PWR FAST 50	Power Fast 50 450 VAC	465 \$	50	400	1
PWR FAST 75	Power Fast 75 450 VAC	640 \$	75	400	1
PWR FAST 100	Power Fast 100 450 VAC	940 \$	100	400	1
PWR FAST 5M	Power Fast 5 M 450 VAC	385 \$	3x1,5	3x 220	1
PWR FAST 15M	Power Fast 15 M 450 VAC	480 \$	3x 5	3x 220	1



Mikroişlemci kontrollüdür. ←

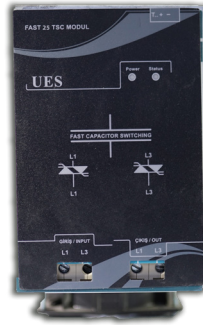
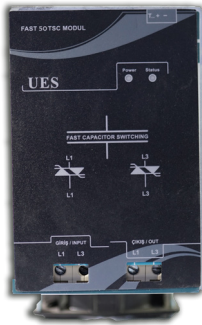

GPRS MODEM

Stok Kodu	Model	Fiyat \$	Koli Adeti
PWR GPRS 100	Power GPRS 100	310 \$	1

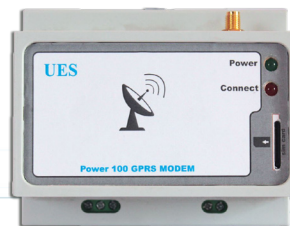

ENERJİ ANALİZÖRLERİ

Stok Kodu	Model	Fiyat \$	Minimum Ölçüm Akımı(mA)	Class	Konatak	3 Faz Akım Trafosu	63. Harmoniğe Kadar Ölçüm	31. Harmoniğe Kadar Ölçüm	Şifre Koruma	Haberleşme	Ekran Tipi	Gerçek Zamanlı Saat ve Hafıza	Dil Desteği	Gelişmiş Alarm	Nötr Akımı Gösterim	Min./Max. Demand	Enerji Sayaçları	Koli Adeti
PWR EA 01	Power EA 01	175 \$	5	0,2	LCD	6
PWR EA 02	Power EA 02	208 \$	5	0,2	LCD	6
PWR EA 04	Power EA 04	255 \$	5	0,2	LCD	6

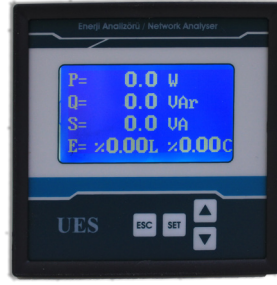

MULTİMETRE

Stok Kodu	Model	Fiyat \$	Koli Adeti
PWR MM 01	Ues mm 01	66 \$	10
MTM 01	Metes Multimetre	62 \$	10
KMM 01 U	Kmm 01 U Krk Multimetre	68 \$	10

→ 3 Faz akım, gerilim, faz- faz gerilim, frekans.

KOMPANZASYON KONTAKTÖRLERİ

CNNK TİPİ KOMPANZASYON KONTAKTÖRLER

Stok Kodu	Model	Fiyat €	Koli Adeti
CNNK 2500	400 V 2,5 kVAr (le-3,6A)	28,42 €	1
CNNK 5000	400 V 5 kVAr (le-7,2A)	30,16 €	1
CNNK 7500	400 V 7,5 kVAr (le-11A)	41,76 €	1
CNNK 1011	400 V 10kVAr (le-14A - 1NA+ 1NK)	55,68 €	1
CNNK 1211	400 V 12,5 kVAr (le-18A - 1NA+ 1NK)	57,13 €	1
CNNK 1511	400 V 15 kVAr (le-22A- 1NA+1NK)	60,75 €	1
CNNK 2010	400 V 20 kVAr (le-29A- 1NA)	69,45 €	1
CNNK 25E10	400 V 25 kVAr (le-36A- 1NA)	83,52 €	1
CNNK 2510	400 V 25 kVAr (le-36A- 1NA)	103,67 €	1
CNNK 3010	400 V 30 kVAr (le-44A- 1NA)	108,31 €	1
CNNK 4010	400 V 40 kVAr (le- 58A- 1NA)	156,02 €	1
CNNK 5010	400 V 50 kVAr (le- 72A- 1NA)	173,56 €	1
CNNK 6010	400 V 60 kVAr (le- 87A- 1NA)	198,21 €	1
CNNK 7010	400 V 70 kVAr (le- 101A- 1NA)	254,47 €	1
CNNK 7510	400 V 75 kVAr (le- 108A- 1NA)	264,04 €	1
CNNK 8022	400 V 80 kVAr (le- 116A- 2NA+ 2NK)	403,68 €	1

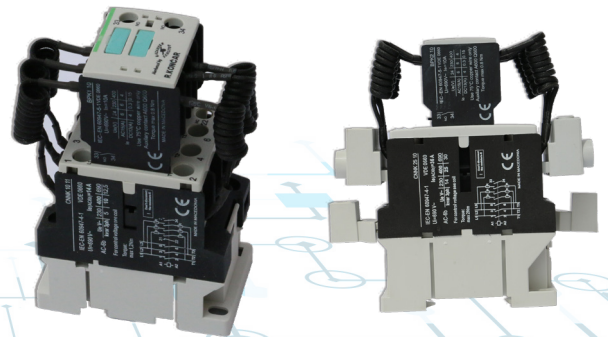
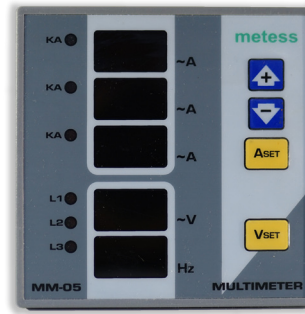

TO.30M

ALÇAK GERİLİM AKIM TRAFOLARI



Teknik Resim

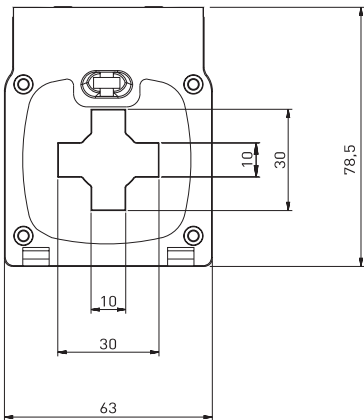
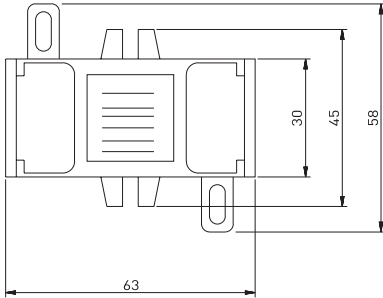

NOT:

- Sekonderi 1A için fiyat sorunuz.
- 0,2 Cl. için fiyat sorunuz.

Sekonder Akım		5A		MÜHÜRLÜ
Primer Anma Akımı (A)	Güç (VA)	Sınıf		Sınıf
		1	0,5	0,5
		Liste Fiyatı	Liste Fiyatı	Liste Fiyatı
30	1,5	619,20		
40	1,5	619,20		
50	1,5	619,20		
60	1,5	619,20		
75	1,5	619,20		
80	1,5	619,20	619,20	741,60
100	1,5	619,20	619,20	741,60
125	1,5	619,20	619,20	741,60
150	1,5 2,5	619,20	619,20	741,60
200	1,5 2,5	619,20	619,20	741,60
250	5	619,20	619,20	741,60
300	5 10	619,20 725,00	619,20	741,60 842,40
400	5 10	648,00 725,00	648,00 725,00	770,40 842,40
500	5 10	648,00 725,00	648,00 725,00	770,40 842,40
600	5 10	648,00 725,00	648,00 725,00	770,40 842,40

TO.B



Teknik Resim

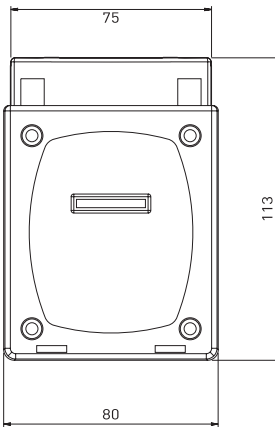
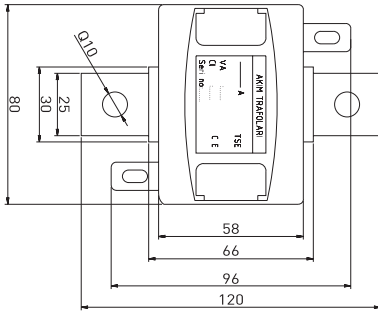

ALÇAK GERİLİM AKIM TRAFOLARI

Sekonder Akım		5A		MÜHÜRLÜ
Primer Anma Akımı (A)	Güç (VA)	Sınıf		Sınıf
		1	0,5	0,5
		Liste Fiyatı		Liste Fiyatı
5	5	1440,00		1560,00
	10	1440,00		
	15	1584,00		
10	5	1440,00		1560,00
	10	1440,00		
	15	1584,00		
15	5	1350,00		1476,00
	10	1350,00		
	15	1425,00		
20	5	1225,00		1380,00
	10	1225,00		
	15	1330,00		
25	5	1225,00		1380,00
	10	1225,00		
	15	1330,00		
30	5	1225,00		1380,00
	10	1225,00		
	15	1330,00		
40	5	1225,00		1380,00
	10	1225,00		
	15	1330,00		
50	5	1225,00		1380,00
	10	1225,00		
	15	1330,00		
60	5	1225,00		1380,00
	10	1225,00		
	15	1330,00		
75	5	1225,00		1380,00
	10	1225,00		
	15	1330,00		
80	5	1225,00		1380,00
	10	1225,00		
	15	1330,00		
100	5	1225,00		1380,00
	10	1225,00		
	15	1330,00		
125	5	1225,00		1380,00
	10	1225,00		
	15	1330,00		
150	5	1225,00		1380,00
	10	1225,00		
	15	1330,00		

NOT:

- Sekonderi 1A için fiyat sorunuz.
- 0,2 Cl. için fiyat sorunuz.

TO.30D



Teknik Resim

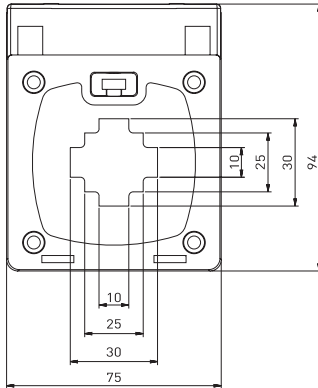
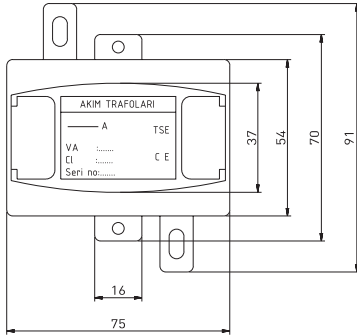

NOT:

- Sekonderi 1A için fiyat sorunuz.
- 0,2 Cl. için fiyat sorunuz.

ALÇAK GERİLİM AKIM TRAFOLARI

Sekonder Akım		5A		MÜHÜRLÜ
Primer Anma Akımı (A)	Güç (VA)	Sınıf		Sınıf
		1	0,5	0,5
		Liste Fiyatı	Liste Fiyatı	Liste Fiyatı
30	2,5 5	910,00		
40	2,5 5	910,00		
50	2,5 5	910,00		
60	2,5 5	910,00		
75	2,5 5	775,00		
80	2,5 5	775,00		
100	2,5 5	775,00	865,00	
125	2,5 5	775,00	865,00	
150	2,5 5	775,00	865,00	985,00
200	5 10	865,00	865,00	985,00
250	5 10	775,00	755,00	875,00
300	5 10	795,00	795,00	915,00
400	5 10	720,00	720,00	840,00
500	5 10	720,00	720,00	840,00
600	5 10	755,00	755,00	875,00

HARMONİK FİLTRE

400VAC STANDART TRİFAZE HARMONİK FİLTRELER (P=%7)

Stok Kodu	Model	Fiyat \$	Gerilim (V)	Koli Adeti
THF 050	0,5 kVAr	77 \$	400	1
THF 1	1 kVAr	79 \$	400	1
THF 150	1,5 kVAr	96 \$	400	1
THF 2	2 kVAr	100 \$	400	1
THF 250	2,5 kVAr	101 \$	400	1
THF 3	3 kVAr	105 \$	400	1
THF 350	3,5 kVAr	105 \$	400	1
THF 4	4 kVAr	107 \$	400	1
THF 450	4,5 kVAr	108 \$	400	1
THF 5	5 kVAr	108 \$	400	1
THF 625	6,25 kVAr	114 \$	400	1
THF 750	7,5 kVAr	123 \$	400	1
THF 10	10 kVAr	142 \$	400	1
THF 1250	12,5 kVAr	160 \$	400	1
THF 15	15 kVAr	170 \$	400	1
THF 20	20 kVAr	180 \$	400	1
THF 25	25 kVAr	183 \$	400	1
THF 30	30 kVAr	225 \$	400	1
THF 40	40 kVAr	240 \$	400	1
THF 50	50 kVAr	271 \$	400	1
THF 60	60 kVAr	428 \$	400	1
THF 75	75 kVAr	469 \$	400	1
THF 100	100 kVAr	570 \$	400	1

400 VAC ENDÜSTRİYEL TRİFAZE HARMONİK FİLTRELER (P=%7)

Stok Kodu	Model	Fiyat \$	Gerilim (V)	1Koli Adıdeti
ETHF050	0,5 kVAr	82 \$	400	1
ETHF 1	1 kVAr	86 \$	400	1
ETHF 150	1,5 kVAr	103 \$	400	1
ETHF 2	2 kVAr	104 \$	400	1
ETHF 250	2,5 kVAr	106 \$	400	1
ETHF 3	3 kVAr	108 \$	400	1
ETHF 350	3,5 kVAr	109 \$	400	1
ETHF 4	4 kVAr	112 \$	400	1
ETHF 450	4,5 kVAr	114 \$	400	1
ETHF 5	5 kVAr	116 \$	400	1
ETHF 625	6,25 kVAr	120 \$	400	1
ETHF 750	7,5 kVAr	128 \$	400	1
ETHF 10	10 kVAr	162 \$	400	1
ETHF 1250	12,5 kVAr	173 \$	400	1
ETHF 15	15 kVAr	194 \$	400	1
ETHF 20	20 kVAr	223 \$	400	1
ETHF 25	25 kVAr	314 \$	400	1
ETHF 30	30 kVAr	328 \$	400	1
ETHF 40	40 kVAr	342 \$	400	1
ETHF 50	50 kVAr	394 \$	400	1
ETHF 60	60 kVAr	513 \$	400	1
ETHF 75	75 kVAr	657 \$	400	1
ETHF 80	80 kVAr	684 \$	400	1
ETHF 1003	100 kVAr	770 \$	400	1

230 VAC MONOFAZE HARMONİK FİLTRE (P=%7)

Stok Kodu	Model	Fiyat \$	Gerilim (V)	Koli Adeti
MHF 055	0,55 kVAr	41 \$	230	1
MHF083	0,83 kVAr	44 \$	230	1
MHF 1	1 kVAr	49 \$	230	1
MHF 150	1,5 kVAr	57 \$	230	1
MHF 2	2 kVAr	60 \$	230	1
MHF 250	2,5 kVAr	64 \$	230	1
MHF 3	3 kVAr	80 \$	230	1
MHF 4	4 kVAr	112 \$	230	1
MHF 5	5 kVAr	118 \$	230	1
MHF 750	7,5 kVAr	150 \$	230	1
MHF 10	10 kVAr	192 \$	230	1

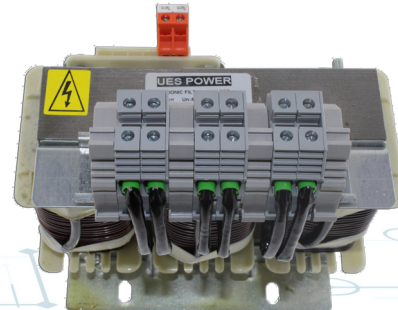
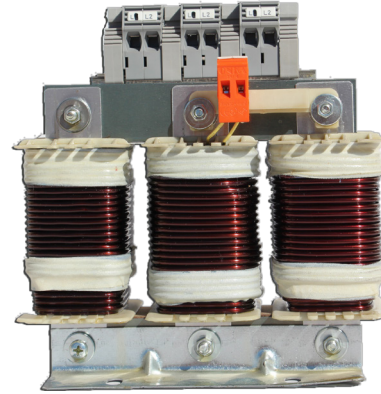
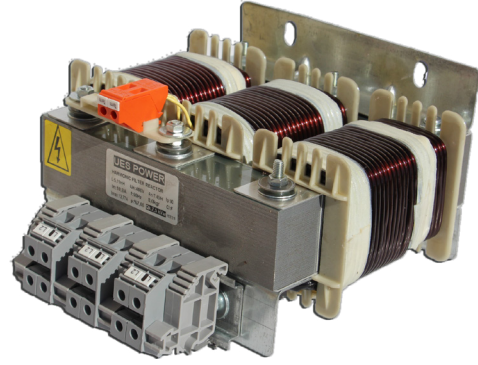

ŞÖNT REAKTÖRÜ

230 VAC MONOFAZE ŞÖNT REAKTÖRLERİ

Stok Kodu	Model 400 VAC	Fiyat \$	Gerilim (V)	Koli Adeti
MSR 010	0,1 kVAr	63 \$	230	1
MSR 030	0,3 kVAr	69 \$	230	1
MSR 050	0,5 kVAr	75 \$	230	1
MSR 1	1 kVAr	95 \$	230	1
MSR 150	1,5 kVAr	98 \$	230	1
MSR 166	1,66 kVAr	108 \$	230	1
MSR 250	2,5 kVAr	165 \$	230	1
MSR 3	3 kVAr	191 \$	230	1
MSR 330	3,33 kVAr	240 \$	230	1
MSR 5	5 kVAr	302 \$	230	1
MSR 750	7,5 kVAr	416 \$	230	1
MSR 10	10 kVAr	479 \$	230	1

230 VAC MONOFAZE ECO ŞÖNT REAKTÖRÜ

Stok Kodu	Model 400 VAC	Fiyat \$	Gerilim (V)	Koli Adeti
EMR 1	1 kVAr	86 \$	230	1
EMR 150	1,5 kVAr	89 \$	230	1
EMR 166	1,66 kVAr	99 \$	230	1
EMR 250	2,5 kVAr	150 \$	230	1
EMR 3	3 kVAr	175 \$	230	1
EMR 330	3,3 kVAr	218 \$	230	1
EMR 5	5 kVAr	275 \$	230	1
EMR 750	7,5 kVAr	380 \$	230	1
EMR 10	10 kVAr	436 \$	230	1

→ Reaktörler, 120 C Termostatlıdır.
1 kVAr ve üstü U bobinlidir. Ürünlerin çalışma fasılası %50 c.
Çalışma ısıları standart reaktörlerden üsttedir.

400 VAC TRİFAZE ŞÖNT REAKTÖRÜ

Stok Kodu	Model 400 VAC	Fiyat \$	Gerilim (V)	Koli Adeti
TSR 050	0,5 kVAr	97 \$	400	1
TSR 1	1 kVAr	117 \$	400	1
TSR 150	1,5 kVAr	171 \$	400	1
TSR 2	2 kVAr	194 \$	400	1
TSR 250	2,5 kVAr	200 \$	400	1
TSR 3	3 kVAr	328 \$	400	1
TSR 4	4 kVAr	370 \$	400	1
TSR 5	5 kVAr	387 \$	400	1
TSR 6	6 kVAr	412 \$	400	1
TSR 750	7,5 kVAr	481 \$	400	1
TSR 10	10 kVAr	684 \$	400	1
TSR 1250	12,5 kVAr	868 \$	400	1
TSR 15	15 kVAr	884 \$	400	1
TSR 20	20 kVAr	1126 \$	400	1
TSR 25	25 kVAr	1348 \$	400	1
TSR 30	30 kVAr	1569 \$	400	1
TSR 40	40 kVAr	2280 \$	400	1
TSR 50	50 kVAr	2622 \$	400	1

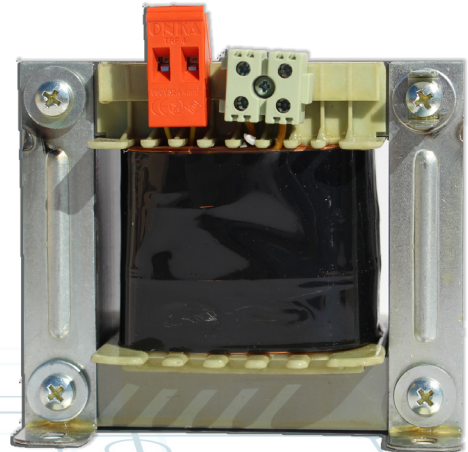
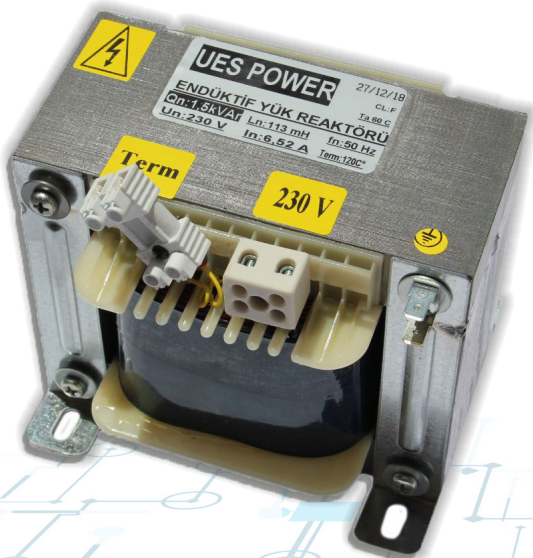
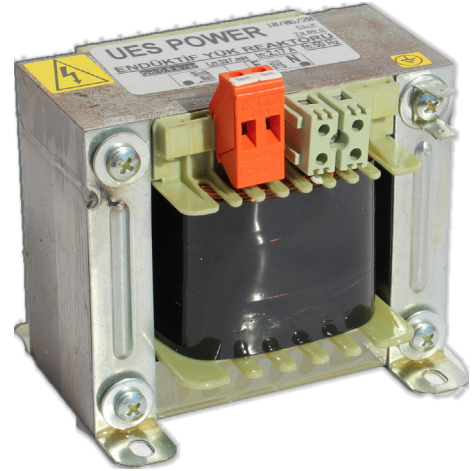

SİLİNDİRİK ALÜMİNYUM TÜP A.G. GÜÇ KONDANSATÖRLERİ

ZnPS SİLİNDİRİK TİP 3 FAZ ALÇAK GERİLİM GÜÇ KONDANSATÖRLERİ

GERİLİM	400 V.	415 V.		ÜRÜN KODU	KAPASİTE (µf)	BİRİM FİYAT TL	KOLİ ADEDİ
400V. 50 Hz. GÜÇ / kVAR	0,5	0,53		YG12D01B0	10	765,00	12
	1	1,1	YG12D01D0	20	786,00	12	
	1,5	1,6	YG12D01G0	30	822,00	12	
	2,5	2,7	YG12D01K0	50	973,00	12	
	5	5,4	YG12D01S0	100	1315,00	12	
	7,5	8,1	YG12D01V0	150	1716,00	6	
	10	10,8	YG12D01X0	200	1916,00	6	
	12,5	13,5	YG12D01Y0	250	2217,00	6	
	15	16,1	YG12D0160	300	2574,00	6	
	20	21,5	YG12D0180	400	3217,00	6	
	25	26,9	YG12D0190	500	3575,00	4	
	30	32,3	YG12D0A00	600	3999,00	4	

GERİLİM	440 V	415 V.	400 V.	ÜRÜN KODU	KAPASİTE (µf)	BİRİM FİYAT TL	KOLİ ADEDİ
440V. 50 Hz. GÜÇ / kVAR	0,5	0,4	0,4	YJ12D01B0	8,22	765,00	12
	1	0,9	0,8	YJ12D01D0	16,5	786,00	12
	1,5	1,3	1,2	YJ12D01G0	25	822,00	12
	2,5	2,2	2,1	YJ12D01K0	41	973,00	12
	5	4,4	4,1	YJ12D01S0	82,5	1315,00	12
	7,5	6,7	6,2	YJ12D01V0	123,6	1716,00	6
	10	8,9	8,3	YJ12D01X0	164,7	1916,00	6
	12,5	11,1	10	YJ12D01Y0	206	2217,00	6
	15	13,3	12,5	YJ12D0160	247	2574,00	6
	20	17,8	16,5	YJ12D0180	330	3217,00	6
	25	22,2	20	YJ12D0190	411	3575,00	4
	30	26,7	25	YJ12D0A00	493,5	3999,00	4

GERİLİM	480 V.	440 V.	2 Faz 2 Uçlu	ÜRÜN KODU	KAPASİTE (µf)	BİRİM FİYAT TL	KOLİ ADEDİ
480V.50Hz. z. Güç/kVAR	16,6	14,1		YY12D0170	230	2788,00	6
	33,3	28,2		YY12D0H00	460	4504,00	4
	33,3	28,2	YY12P0H00	460	4504,00	4	

GERİLİM	525 V.	480 V.	440 V.	ÜRÜN KODU	KAPASİTE (µf)	BİRİM FİYAT TL	KOLİ ADEDİ
525V. 50 Hz. GÜÇ / kVAR	2,5	2,1	1,8	YO12D01K0	29	972,00	12
	5	4,2	3,5	YO12D01S0	58	1315,00	12
	7,5	6,2	5,3	YO12D01V0	87	1716,00	6
	10	8,3	7	YO12D01X0	116	1916,00	6
	12,5	10,4	8,8	YO12D01Y0	145	2217,00	6
	15	12,5	10,5	YO12D0160	173	2574,00	6
	20	16,6	14,1	YO12D0180	231	3217,00	6
	25	20,8	17,5	YO12D0190	289	3217,00	4
	30	25,0	21,1	YO12D0A00	348	4000,00	4
	40	33,3	28,2	YO12D0280	462	5434,00	2
	50	41,7	35	YO12D0290	578	6721,00	2

ZnPS SİLİNDİRİK TİP 1-2 (MONOFAZ - DİFAZ) ALÇAK GERİLİM GÜÇ KONDANSATÖRLERİ

GERİLİM	230 V.	400 V.		ÜRÜN KODU	KAPASİTE (µf)	BİRİM FİYAT TL	KOLİ ADEDİ
230V. 50 Hz. GÜÇ / kVAR	0,25	0,75		Y412M01A0	15,1	769,00	12
	0,5	1,5	Y412M01B0	30,1	822,00	12	
	1	3	Y412M01D0	60,2	1072,00	12	
	1,5	4,5	Y412M01G0	90,3	1287,00	12	
	2,5	7,5	Y412M01K0	150,5	1644,00	12	
	5	15	Y412M01S0	301	2520,00	6	
	10	30	Y412M01X0	602	3932,00	4	

MOTOR İLK HAREKET (START) KONDANSATÖRLERİ

Kapasite / μf	Çap (Ø)	Volt	Fiyat \$
36-43	36	220-250V	2,40 \$
43-53	36	220-250V	2,50 \$
47-56	36	220-250V	2,65 \$
53-64	36	220-250V	2,75 \$
64-77	36	220-250V	2,90 \$
72-88	36	220-250V	3,00 \$
88-108	36-46	220-250V	3,15 \$
108-130	36-46	220-250V	3,70 \$
124-149	36-46	220-250V	3,85 \$
130-156	36-46	220-250V	4,00 \$
145-175	36-46	220-250V	4,30 \$
161-193	46	220-250V	4,45 \$
189-227	46	220-250V	4,60 \$
216-259	46	220-250V	4,90 \$
233-280	46	220-250V	5,75 \$
280-33	46	220-250V	5,98 \$



DAİMİ DEVRE KONDANSATÖRLERİ

KAPASİTE / μf CBB 60	Ölçüler (mm)	Pls. Tüp Kablolü 400/450V Adet / (\$)
0,5	25 x 65	1,35 \$
1	25 x 65	1,35 \$
1,25	25 x 65	1,38 \$
1,5	25 x 65	1,40 \$
2	25 x 65	1,42 \$
2,5	25 x 65	1,49 \$
3	25 x 65	1,52 \$
3,15-3,5	25 x 65	1,59 \$
4	25 x 65	1,61 \$
4,5	30 x 65	1,62 \$
5	30 x 63	1,65 \$
6	30 x 63	1,82 \$
6,3-6,5	30 x 63	1,95 \$
7	30 x 63	1,96 \$
7,5	30 x 63	1,97 \$
8	30 x 63	2,16 \$
9	30 x 63	2,37 \$
10	34 x 63	2,39 \$
12	34 x 71	1,45 \$
12,5	34 x 71	2,46 \$
14	34 x 71	3,17 \$
15	34 x 71	3,27 \$
16	34 x 71	3,35 \$
18	40 x 72	3,37 \$
20	40 x 72	3,42 \$
25	40 x 72	4,05 \$
30	44 x 72	4,65 \$
32	44 x 72	5,06 \$
35	44 x 72	5,16 \$
40	44 x 95	5,73 \$
45	44 x 95	6,29 \$
50	48 x 95	6,68 \$
55	48 x 102	7,08 \$
60	48 x 102	7,64 \$
65	48 x 102	9,11 \$
70	55 x 123	10,12 \$
80	55 x 123	10,33 \$
85	55 x 123	12,01 \$
90	55 x 123	12,55 \$
100	58 x 123	12,95 \$







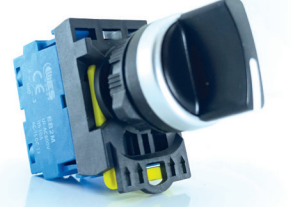

Ø 22mm BUTON SERİSİ KALICI MANDAL BUTONLAR

Sipariş Kodu	Ürün Kodu	Kontak	Açıklama	Kutu Adet	Koli Adet	Fiyat TL. / AD.
PWR A-10X	A - 10X	1NO	0-1 Mandal Buton 	10	300	106,70
PWR A-20XS	A - 20XS	2NO	1-0-2 Mandal Buton 	10	300	144,10



Ø 22mm BUTON SERİSİ YAYLI BUTONLAR

Sipariş Kodu	Ürün Kodu	Kontak	Açıklama	Renk	Kutu Adet	Koli Adet	Fiyat TL. / AD.
PWR A-10X	A - 10	1NO	Yaylı Buton	 Yeşil	10	300	92,40
PWR A-01X	A - 01	1NC	Yaylı Buton	 Kırmızı	10	300	92,40
PWR A-11X	A - 11	1NO	Yaylı Buton	 Sarı	10	300	92,40
PWR A-21X	A - 21	1NO	Yaylı Buton	 Mavi	10	300	92,40
PWR A-31X	A - 31	1NO	Yaylı Buton	 Beyaz	10	300	92,40
PWR A-41X	A - 41	1NO	Yaylı Buton	 Siyah	10	300	92,40

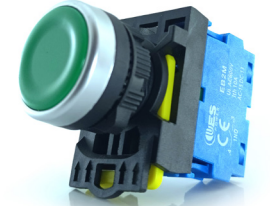
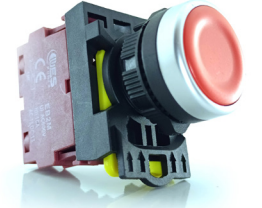

Ø 22mm BUTON SERİSİ 40 mm KALICI MANTAR BUTON

Sipariş Kodu	Ürün Kodu	Kontak	Açıklama	Renk	Kutu Adet	Koli Adet	Fiyat TL. / AD.
PWR A-01 ZS	A - 01ZS	1NC	Stop Mantar Button	 Kırmızı	10	300	123,20



KUTULU MONTAJLI ÜRÜNLER

Stok Kodu	Model	Fiyat \$	Ölçüler			Koli Adeti
			U	G	D	
ELX- BXL-AS	Acil Stop 40mm 1NC Kalıcı Kutu	4,04 \$	70	70	60	1
Stok Kodu	Model	Fiyat \$	Ölçüler			Koli Adeti
ELX- BXL-ASK	Acil Stop 40mm 1NC Kalıcı Korumalı Kutu	4,20 \$	70	70	60	
Stok Kodu	Model	Fiyat \$	Ölçüler			Koli Adeti
ELX- BOX-1	1'li Boş Buton Kutusu	1,34 \$	70	70	60	

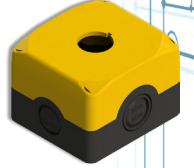

Plastik Buton Serisi

YAYLI BUTONLAR 250 VAC/3A (IP44)

Stok Kodu	Model	Fiyat \$	Renk	Kontakt	Koli Adeti
LAY5 (DB2) EA31	Q22mm Start Buton	1.35.\$	Yeşil	1 NO	1
LAY5 (DB2) EA42	Q22mm StopButon	1.35.\$	Kırmızı	1 NC	1
LAY5 (DB2) EA51	Q22mm Start Buton	1.35.\$	Sarı	1 NO	1
LAY5 (DB2) EA21	Q22mm Start Buton	1.35.\$	Siyah	1 NO	1



MANDAL BUTONLAR 250 VAC/3A (IP44)

Stok Kodu	Model	Fiyat \$	Konum	Kontakt	Koli Adeti
LAY5 (DB2) ED21	Q22mm Kalıcı Buton	1.57 \$	0-1 Kalıcı	1 NO	1
LAY5 (DB2) ED33	Q22mm Kalıcı Buton	3.17 \$	1-0-2 Kalıcı	1 NO+ 1NO	1
LAY5 (DB2) ED53	Q22mm Kayıcı Buton	3.30 \$	1-0-2 Kayıcı	1 NO+1NO	1



40MM MANTAR BUTONLAR 250 VAC/3A (IP44)

Stok Kodu	Model	Fiyat \$	Renk	Kontakt	Koli Adeti
LAY5 (DB2) ES542	Q40mm Acil Stop Mantar	2.16 \$	Kırmızı	1 NC	1
LAY5 (DB2) ES442	Q30mm Acil Stop Mantar	2.16 \$	Kırmızı	1 NC	1
LAY5 (DB2) ES142	Q40mm Anahtarlı Buton	4.73 \$	Kırmızı	1 NC	1
LAY5 (DB2) EC42	Q40mm Acil Stop Mantar	2.16 \$	Kırmızı	1 NC	1
LAY5 (DB2) EC31	Q40mm Acil Stop Mantar	2.16 \$	Yeşil	1 NO	1



YEDEK KONTAK BLOK 250 VAC/3A (IP44)

Stok Kodu	Model	Fiyat \$	Renk	Kontakt	Koli Adeti
LAY5 (DB2) BE101	Yedek Kontakt Blok	0.73 \$	Yeşil	1 NO	1
LAY5 (DB2) BE102	Yedek Kontakt Blok	0.73 \$	Kırmızı	1 NC	1



Ø 22 MM POTANSİYOMETRE TEK TUR

Stok Kodu	Model	Fiyat \$	Kontakt	Koli Adeti
ELX PT 5K	Ø22mm Potansiyometre	9.07 \$	5K (Tek Tur)	1
ELX PT 10K	Ø22mm Potansiyometre	9.07 \$	10K (Tek Tur)	1

Ø 22mm BUTON SERİSİ BUTON AKSESUARLARI

Sipariş Kodu	Ürün Kodu	Açıklama	Kutu Adet	TL. / AD.
7101	A - 10	1NO Start Kontak	50	38,50
7102	A- 01	1NC Stop Kontak	50	38,50
7103	A - D2	BA9S Led Kontak Yuvası (Buton için)	200	46,20
7104	XB2-EH2201	Plastik Buton Rozeti	100	5,50
7105	XB2-EH2208	Plastik Buton Rozeti (Geniş Etiketli)	100	5,50
7106	XB2-ER60	60mm Acil Stop Etiketi	100	15,60
7107	XB2-EC2	Acil Stop Butonu Koruma Kapağı	20	92,50
7108	XB2-EB40P	Buton Koruma Kapağı	5	77,00
7109	XB2-PE16A	Buton Koruma Kılıfı	100	12,10
7110	XB2-EC3	Acil Stop Butonu Koruma Kapağı	10	90,20



Ø 22 mm LED'li SİNYALLER

Sipariş Kodu	Ürün Kodu	Çap (mm)	Açıklama	Renk	Kutu Adet	Koli Adet	Fiyat TL. / AD.
7311	AD136-22DS-K	22	Led Sinyal 220V AC/DC	● Kırmızı	10	500	35,20
7312	AD136-22DS-Y	22	Led Sinyal 220V AC/DC	● Yeşil	10	500	35,20
7313	AD136-22DS-S	22	Led Sinyal 220V AC/DC	● Sarı	10	500	35,20
7314	AD136-22DS-M	22	Led Sinyal 220V AC/DC	● Mavi	10	500	35,20
7315	AD136-22DS-B	22	Led Sinyal 220V AC/DC	○ Beyaz	10	500	41,80
7316	AD136-22DS-110-K	22	Led Sinyal 110V AC/DC	● Kırmızı	10	500	35,20
7317	AD136-22DS-110-Y	22	Led Sinyal 110V AC/DC	● Yeşil	10	500	35,20
7318	AD136-22DS-110-S	22	Led Sinyal 110V AC/DC	● Sarı	10	500	35,20
7319	AD136-22DS-110-M	22	Led Sinyal 110V AC/DC	● Mavi	10	500	35,20
7320	AD136-22DS-110-B	22	Led Sinyal 110V AC/DC	○ Beyaz	10	500	41,80
7321	AD136-22DS-24-K	22	Led Sinyal 24V AC/DC	● Kırmızı	10	500	35,20
7322	AD136-22DS-24-Y	22	Led Sinyal 24V AC/DC	● Yeşil	10	500	35,20
7323	AD136-22DS-24-S	22	Led Sinyal 24V AC/DC	● Sarı	10	500	35,20
7324	AD136-22DS-24-M	22	Led Sinyal 24V AC/DC	● Mavi	10	500	35,20
7325	AD136-22DS-24-B	22	Led Sinyal 24V AC/DC	○ Beyaz	10	500	41,80



BUZZERLAR Ø 22 mm LEDLİ BUZZER



Sipariş Kodu	Ürün Kodu	Çap (mm)	Açıklama	Renk	Kutu Adet	Koli Adet	Fiyat TL. / AD.
7433	22DS/MS	22	Sesli Led Flaşör İkazlı 220V. AC/DC	● Kırmızı	10	500	143,00
7434	22DS-MS110	22	Sesli Led Flaşör İkazlı 110V. AC/DC	● Kırmızı	10	500	143,00
7435	22DS/MS24	22	Sesli Led Flaşör İkazlı 24V. AC/DC	● Kırmızı	10	500	143,00
7451	22DS/MS12	22	Sesli Led Flaşör İkazlı 12V. AC/DC	● Kırmızı	10	500	143,00

Ø 22 mm SESLİ BUZZER



Sipariş Kodu	Ürün Kodu	Çap (mm)	Açıklama	Renk	Kutu Adet	Koli Adet	Fiyat TL. / AD.
7436	22DS/M	22	Sesli İkazlı 220V. AC/DC	● Siyah	10	500	68,00
7437	22DS/M24	22	Sesli İkazlı 24V. AC/DC	● Siyah	10	500	68,00
7438	22DS-M110	22	Sesli İkazlı 110V. AC/DC	● Siyah	10	500	68,00

PANO SARF MALZEMELERİ

SAÇ MONTAJ RAYLARI

Stok Kodu	Model	Fiyat TL	Boy	Koli Adeti
PWR 90050	Düz W Otomat Rayı 35x 7,5	21,50	50 cm	40
PWR 90001	Düz W Otomat Rayı 35x 7,5	43,00	100 cm	40
PWR 90002	Düz W Otomat Rayı 35x 7,5	86,00	200 cm	40
PWR 90150	Delikli W Otomat Rayı 35x 7,5	21,50	50 cm	40
PWR 90101	Delikli W Otomat Rayı 35x 7,5	43,00	100 cm	40
PWR 90102	Delikli W Otomat Rayı 35x 7,5	86,00	200 cm	40
PWR 99452	Düz W Otomat Rayı 35x 15	67,50	50 cm	40
PWR 99401	Düz W Otomat Rayı 35x 15	135,00	100 cm	40
PWR 99402	Düz W Otomat Rayı 35x 15	270,00	200 cm	40
PWR 99405	Delikli W Otomat Rayı 35x 15	67,50	50 cm	40
PWR 99451	Delikli W Otomat Rayı 35x 15	135,00	100 cm	40
PWR 99452	Delikli W Otomat Rayı 35x 15	270,00	200 cm	40



PANO TİPİ TERMOSTATLAR

Stok Kodu	Model	Fiyat TL
TPM 0P 0070	Mekanik Pano Termostatı NK Kontak, 0-70°C	245,00
TPM 1P 0070	Mekanik Pano Termostatı NA Kontak, 0-70°C	245,00
TWM 0P 0070	W Otomat Tipi Mekanik Pano Termostatı NK Kontak, 0-70°C	245,00
TWM 1P 0070	W Otomat Tipi Mekanik Pano Termostatı NA Kontak, 0-70°C	245,00
TWE 0P 0070	W Otomat Tipi Elektrikli Pano Termostatı NK Kontak, 0-70°C	245,00
TWE 1P 0070	W Otomat Tipi Elektrikli Pano Termostatı NA Kontak, 0-70°C	245,00



ERİYEN BANTLAR

Stok Kodu	Model	Fiyat \$	Ölçüler	Koli Adeti
5701	JB- 1401 Eriyen Bant	2,36 \$	19mm x 0.8mm x 8m	80
5702	JB- 1402 Eriyen Bant	6,05 \$	50mm x 0.8mm x 8m	32

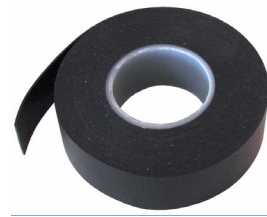

RAYA MONTAJLI PRİZ

Stok Kodu	Model	Fiyat TL	Açıklama	Kutu Adeti
4103	JPP	190,00	Raya Montaj (Kapaklı) Pano Prizi (16A/250V)	10

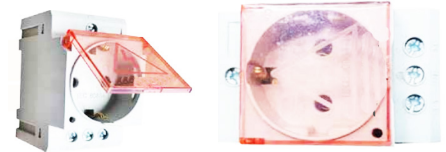

JKS SERİSİ KAPI SİVİÇLERİ

Stok Kodu	Model	Fiyat TL	Kontak	Açıklama	Kutu Adeti	Koli Adeti
5808	JKS-10	60,00	NO	Açık Kontak Kapı Sivici	50	500
5809	JKS-01	65,00	NC	Kapalı Kontak Kapı Sivici	50	500
5810	JKS- 12	80,00	INO+ 1NC	(1NA+ 1NK)	30	500



STANDART BEYAZ KABLO BAĞLARI

Stok Kodu	Model	Fiyat TL	Boyutlar		Renk	Maksimum Sıkma Çapı (mm)	Açıklama Mukavemeti (mm)	Paket Adeti	Koli Adeti
			Uzunluk (mm)	En (mm)					
3001	JKB-2510B	0.240	100	2.5	Beyaz	20	8	100	50.000
3002	JKB-2515B	0.360	150		Beyaz	36		100	40.000
3003	JKB-2520B	0.528	200		Beyaz	52		100	30.000

Stok Kodu	Model	Fiyat TL	Boyutlar		Renk	Maksimum Sıkma Çapı (mm)	Açıklama Mukavemeti (mm)	Paket Adeti	Koli Adeti
			Uzunluk (mm)	En (mm)					
3004	JKB 3615B	0.618	150	3.6	Beyaz	36	18	100	30.000
3005	JKB 3620B	0.810	200		Beyaz	52		100	20.000
3006	JKB-3625B	0.972	250		Beyaz	68		100	20.000
3007	JKB-3630B	1.230	300		Beyaz	84		100	17.000
3008	JKB-3637B	1.548	370		Beyaz	106		100	12.000

Stok Kodu	Model	Fiyat TL	Boyutlar		Renk	Maksimum Sıkma Çapı (mm)	Açıklama Mukavemeti (mm)	Paket Adeti	Koli Adeti
			Uzunluk (mm)	En (mm)					
3009	JKB-4820B	1.140	200	4.8	Beyaz	50	22	100	16.000
3010	JKB-4825B	1.404	250		Beyaz	65		100	12.000
3011	JKB-4830B	1.680	300		Beyaz	81		100	11.000
3012	JKB-4837B	1.980	370		Beyaz	104		100	9.000
3013	JKB-4843B	2.640	430		Beyaz	123		100	7.500
3014	JKB-4855B	2.622	550		Beyaz	160		100	5.000

Stok Kodu	Model	Fiyat TL	Boyutlar		Renk	Maksimum Sıkma Çapı (mm)	Açıklama Mukavemeti (mm)	Paket Adeti	Koli Adeti
			Uzunluk (mm)	En (mm)					
3015	JKB-7630B	3.336	300	7.6	Beyaz	76	55	100	5.000
3016	JKB-7637B	3.780	370		Beyaz	102		100	4.000
3017	JKB-7645B	4.440	430		Beyaz	110		100	2.500
3018	JKB-7655B	5.700	530		Beyaz	140		100	2.000
3019	JKB-7661B	6.320	610		Beyaz	185		100	2.000
3020	JKB-7675B	8.700	750		Beyaz	226		100	2.000

Stok Kodu	Model	Fiyat TL	Boyutlar		Renk	Maksimum Sıkma Çapı (mm)	Açıklama Mukavemeti (mm)	Paket Adeti	Koli Adeti
			Uzunluk (mm)	En (mm)					
3022	JKB-9710B	9.420	710	9	Beyaz	190	80	100	2.000
3023	JKB-9780B	11.400	780		Beyaz	228		100	2.000
3024	JKB-9920B	12.900	920		Beyaz	280		100	1.000
3025	JKB-91020B	13.440	1020		Beyaz	295		100	1.000
3026	JKB-91220B	17.100	1220		Beyaz	375		100	1.000

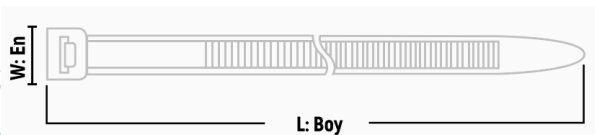

KABLO TOPLAMA SPIRALLERİ

Stok Kodu	Model	Fiyat TL	O.D.	T	W	Kablo Kesiti (mm ²)	Renk	Paket Adeti (Mt)	Koli Adeti (Mt)
3701	JHS-6 (No1)	7,95	6	0.60	7.4	2.5 - 15	Beyaz	10	1.000
3702	JHS-8 (No2)	9,10	8	0.75	12	6 - 30	Beyaz	10	800
3703	JHS-10 (No3)	11,20	10	0.80	12.3	7.5 - 30	Beyaz	10	500
3704	JHS-12 (No4)	16,90	12	0.85	15	9 - 32	Beyaz	10	400
3705	JHS-15 (No5)	21,60	15	1.00	15.5	12 - 35	Beyaz	10	250

Malzeme: PE

Esnek yapısı sayesinde kabloların düzenlemesine yardımcı olur. güçlü yapısı sayesinde tekrar kullanım için uygundur.

YAPIŞKANLI KROŞELER

Stok Kodu	Model	Fiyat TL	Boyutlar					Renk	Paket Adeti	Koli Adeti
			A	B	C	D	E			
3513	JYK-1919B	1,08	19	19	3.6	Ø3.2	4.0	Beyaz	100	20.000
3514	JYK-2828B	1,85	28	28	4.8	Ø3.2	4.5	Beyaz	100	5.000
3515	JYK-1919S	1,08	19	19	3.6	Ø3.2	4.0	Siyah	100	20.000
3516	JYK-2828S	1,85	28	28	4.8	Ø3.2	4.5	Siyah	100	5.000

Malzeme: ABS Altlık, PS Kapak + Çift Taraflı Bant
Çalışma Sıcaklığı: -40°C «» +60°C

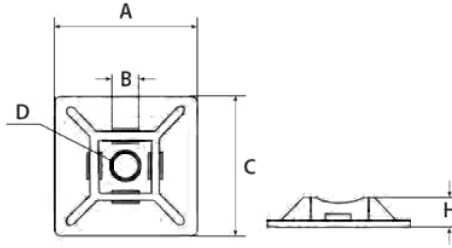

YAPIŞKANLI PANO ETİKET TAŞIYICI

Stok Kodu	Model	Fiyat TL	Boyutlar		En (mm)	Boy (mm)	Renk	Paket Adeti	Koli Adeti
			A	B					
3529	JET-1	2,45	30	17	27.5	14.4	Siyah	100	12.500
3530	JET-2	2,95	50	17	49	15	Siyah	100	6.000
3531	JET-3	4,10	75	17	72	15	Siyah	100	5.000



Malzeme: ABS Altlık, PS Kapak + Çift Taraflı Bant
Çalışma Sıcaklığı: -40°C «» +60°C

FANLAR

ÜRÜN KODU	KUTU ADET	Birim Fiyat USD.
JF-8025-24V	50	6,75 \$
JF-8025-220V	50	9,00 \$
JF-12025-24V	40	6,00 \$
JF-12025-220V	40	11,25 \$
JF-17050-24V	25	42,00 \$
JF-17050-220V	25	27,00 \$
JF-22580-220V	10	109,50 \$



FAN FİLTRELERİ

ÜRÜN KODU	KUTU ADET	Birim Fiyat USD.
JF-107F	120	6,00 \$
JF-148F	60	6,15 \$
JF-205F	40	8,25 \$
JF-255F	30	22,50 \$



FAN KORUMA TELLERİ

ÜRÜN KODU	KUTU ADET	Birim Fiyat USD.
JF-80M	500	2,02 \$
JF-120M	200	2,08 \$
JF-170M	100	2,50 \$
JF-225M	50	12,75 \$

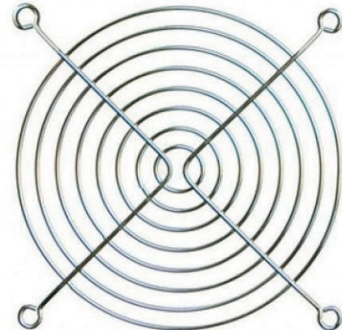

ISI İLE DARALAN SİYAH MAKARONLAR

Sipariş Kodu	Ölçü		Daralmadan Önce (mm)		Daralmadan Sonra (mm)		Makara / Mt.	Koli Miktarı	Birim Fiyatı USD / Mt.
	Inch	mm	İç Çap	Cidar Kalınlığı	İç Çap	Cidar Kalınlığı			
5015	—	1	2.0 ± 0.3	0.16 ± 0.05	0.70	0.30 ± 0.05	200	3200	0.085
5016	—	1.5	2.0 ± 0.3	0.16 ± 0.05	0.80	0.30 ± 0.05	200	2400	0.097
5017	—	2	2.5 ± 0.3	0.16 ± 0.05	1.00	0.35 ± 0.05	200	3000	0.115
5018	3/32	2.4	3.0 ± 0.3	0.16 ± 0.05	1.50	0.35 ± 0.05	200	3000	0.115
5019	—	2.5	3.0 ± 0.3	0.16 ± 0.05	1.25	0.38 ± 0.05	200	2600	0.15
5020	—	3	3.4 ± 0.4	0.20 ± 0.05	1.50	0.38 ± 0.05	200	2200	0.16
5021	1/8	3.2	3.5 ± 0.4	0.20 ± 0.05	1.75	0.40 ± 0.05	200	2200	0.16
5022	—	3.5	4.0 ± 0.4	0.20 ± 0.05	1.75	0.40 ± 0.05	200	1800	0.17
5023	—	4	4.5 ± 0.4	0.20 ± 0.05	2.00	0.45 ± 0.05	200	1400	0.20
5024	—	4.5	4.8 ± 0.4	0.20 ± 0.05	2.00	0.47 ± 0.08	100	1000	0.23
5025	3/16	4.8	5.2 ± 0.4	0.20 ± 0.05	2.60	0.47 ± 0.08	100	1000	0.23
5026	—	5	5.5 ± 0.4	0.20 ± 0.05	2.50	0.55 ± 0.08	100	900	0.25
5027	—	6	6.5 ± 0.4	0.22 ± 0.05	3.00	0.55 ± 0.05	100	700	0.29
5028	1/4	6.4	7.0 ± 0.4	0.28 ± 0.05	3.50	0.55 ± 0.08	100	700	0.29
5029	—	7	7.5 ± 0.4	0.28 ± 0.05	3.50	0.60 ± 0.08	100	500	0.35
5030	—	8	8.5 ± 0.4	0.30 ± 0.08	4.00	0.60 ± 0.08	100	1300	0.35
5031	3/8	9.5	10.0 ± 0.5	0.30 ± 0.08	5.00	0.60 ± 0.08	100	1200	0.35
5032	—	10	10.0 ± 0.5	0.30 ± 0.08	5.00	0.60 ± 0.08	100	1100	0.39
5033	1/2	12.7	13.0 ± 0.5	0.33 ± 0.10	6.50	0.65 ± 0.08	100	1000	0.45
5034	—	13	13.5 ± 0.5	0.33 ± 0.10	6.50	0.65 ± 0.08	100	900	0.48
5035	—	14	14.5 ± 0.5	0.33 ± 0.10	7.00	0.70 ± 0.08	100	900	0.56
5036	4/5	16	16.5 ± 0.6	0.35 ± 0.12	8.00	0.75 ± 0.08	100	800	0.75
5037	—	18	19.0 ± 0.6	0.40 ± 0.15	9.00	0.80 ± 0.15	100	700	0.98
5038	3/4	19.1	20.5 ± 0.6	0.40 ± 0.15	10.00	0.80 ± 0.15	100	700	0.98
5039	—	20	20.5 ± 0.6	0.40 ± 0.15	10.00	0.80 ± 0.15	100	600	1.25
5040	—	22	22.5 ± 0.7	0.45 ± 0.15	12.00	0.95 ± 0.15	100	600	1.55
5041	1	25.4	25.6 ± 0.7	0.45 ± 0.15	12.00	0.95 ± 0.15	50	300	1.65
5042	—	30	31.5 ± 0.7	0.50 ± 0.15	15.00	0.95 ± 0.15	50	250	2.15
5043	1 — 1/4	32	33.0 ± 0.7	0.50 ± 0.15	16.50	0.95 ± 0.15	50	250	2.15
5044	—	35	38.0 ± 0.7	0.50 ± 0.15	16.00	1.00 ± 0.15	50	200	2.70
5045	1 — 1/2	38	40.0 ± 0.7	0.50 ± 0.15	20.00	1.00 ± 0.15	50	200	3.00
5046	—	40	40.5 ± 0.7	0.50 ± 0.15	20.00	1.00 ± 0.15	50	200	3.00
5047	2	51	52.5 ± 0.7	0.50 ± 0.15	25.00	1.00 ± 0.15	25	125	3.80
5048	—	60	60.5 ± 0.8	0.52 ± 0.15	30.00	1.00 ± 0.16	25	100	5.10
5049	—	70	70.5 ± 1.0	0.55 ± 0.15	40.00	1.10 ± 0.18	25	75	6.80
5050	—	80	82.0 ± 1.0	0.55 ± 0.15	40.00	1.10 ± 0.18	25	75	7.50
5051	—	90	90.0 ± 1.0	0.55 ± 0.15	45.00	1.10 ± 0.18	25	50	8.50
5052	4	102	105.0 ± 1.0	0.55 ± 0.15	51.00	1.10 ± 0.18	25	50	9.50
5053	—	120	120.0 ± 1.0	0.55 ± 0.15	60.00	1.10 ± 0.18	25	50	13.00
5054	—	150	150.0 ± 1.0	0.55 ± 0.15	76.00	1.10 ± 0.18	25	50	19.00
5055	—	180	180.0 ± 1.0	0.55 ± 0.15	90.00	1.10 ± 0.18	25	25	27.00

ÇALIŞMA SICAKLIĞI: -55 °C «» +125 °C **MALZEME:** Polyolefin **Daralma Oranı:** 2/1 **Yanmazlık:** Kendi kendine söner

ISI İLE DARALAN RENKLİ MAKARONLAR

ŞEFFAF - BEYAZ - KIRMIZI - MAVİ - SARI - YEŞİL - GRİ

TEKNİK ÖZELLİKLER

Malzeme : Polyolefin

Daralma Oranı : 2/1

Yanmazlık : Kendi kendine söner

Çalışma Sıcaklığı : -55°C -- +125°C



Ölçü		Sipariş Kodu							Makara / Mt.	Koli Miktarı	Fiyat USD / Mt.
Inch	mm	ŞEFFAF	BEYAZ	KIRMIZI	MAVİ	SARI	YEŞİL	GRİ			
—	1.5	5101	5117	5138	5154	5175	5195	5211	200	3.200	0.11
—	2.5	5102	5118	5139	5155	5305	5196	5212	200	2.600	0.17
1/8	3.2	5103	5119	5140	5156	5176	5197	5213	200	2.200	0.20
—	3.5	—	5120	—	5157	5177	—	—	200	1.800	0.21
Yassı	3.5	—	5121	—	5158	5178	—	—	100	1.600	0.21
3/16	4.8	5104	5122	5141	5159	5179	5198	5214	100	1.000	0.27
Yassı	4.8	—	5123	—	5160	5180	—	—	100	1.500	0.27
1/4	6.4	5105	5124	5142	5161	5181	5199	5215	100	700	0.33
Yassı	6.4	—	5125	—	5162	5182	—	—	100	1.500	0.33
Yassı	7	—	5126	—	5163	5183	—	—	100	1.400	0.33
3/8	9.5	5106	5127	5143	5164	5184	5200	5216	100	1.200	0.39
—	13	5107	5128	5144	5165	5185	5201	5217	100	900	0.55
4/5	16	5108	5129	5145	5166	5186	5202	5218	100	800	0.85
—	20	5109	5130	5146	5167	5187	5203	5219	100	600	1.50
1	25.4	5110	5131	5147	5168	5188	5204	5220	50	300	1.90
1 - 1/4	32	5111	5132	5148	5169	5189	5205	5221	50	250	2.40
1 - 1/2	38	5112	5133	5149	5170	5190	5206	5222	50	200	3.60
2	51	5113	5134	5150	5171	5191	5207	5223	25	125	4.20
—	60	5114	5135	5151	5172	5192	5208	5224	25	100	5.80
—	80	5115	5136	5152	5173	5193	5209	5225	25	75	8.00
4	102	5116	5137	5153	5174	5194	5210	5226	25	50	11.00

ISI BÜZÜŞMELİ EK MUFLARI



Stok Kodu	Model	Fiyat TL	Kablo Kesiti (mm ²)
3FB 1-10	Isı Büzüşmeli Ek Muflar (Bakır İletkenler İçin)	162,00	1x10
3FB 1-16		222,00	1x16
3FB 1-25		222,00	1x25
3FB 1-35		342,00	1x35
3FB 1-50		342,00	1x50
3FB 1-70		588,00	1x70
3FB 1-95		588,00	1x95
3FB 1-120		684,00	1x120
3FB 1-150		684,00	1x150
3FB 1-185		900,00	1x185
3FB 1-240		900,00	1x240

Stok Kodu	Model	Fiyat TL	Kablo Kesiti (mm ²)
3FA 1-16	Isı Büzüşmeli Ek Muflar (Alüminyum İletkenler İçin)	210,00	1x16
3FA 1-25		210,00	1x25
3FA 1-35		330,00	1x35
3FA 1-50		330,00	1x50
3FA 1-70		576,00	1x70
3FA 1-95		576,00	1x95
3FA 1-120		660,00	1x120
3FA 1-150		660,00	1x150
3FA 1-185		876,00	1x185
3FA 1-240		876,00	1x240

Stok Kodu	Model	Fiyat TL	Kablo Kesiti (mm ²)
3FB 2-10	Isı Büzüşmeli Ek Muflar (Bakır İletkenler İçin)	192,00	2x10
3FB 2-16		264,00	2x16
3FB 2-25		264,00	2x25
3FB 2-35		420,00	2x35
3FB 2-50		420,00	2x50
3FB 2-70		720,00	2x70
3FB 2-95		720,00	2x95
3FB 2-120		828,00	2x120
3FB 2-150		828,00	2x150
3FB 2-185		102,00	2x185
3FB 2-240		1200,00	2x240

Stok Kodu	Model	Fiyat TL	Kablo Kesiti (mm ²)
3FA 2-16	Isı Büzüşmeli Ek Muflar (Alüminyum İletkenler İçin)	210,00	2x16
3FA 2-25		210,00	2x25
3FA 2-35		408,00	2x35
3FA 2-50		408,00	2x50
3FA 2-70		708,00	2x70
3FA 2-95		708,00	2x95
3FA 2-120		804,00	2x120
3FA 2-150		804,00	2x150
3FA 2-185		996,00	2x185
3FA 2-240		1200,00	2x240



Stok Kodu	Model	Fiyat TL	Kablo Kesiti (mm ²)
3FB 3-10	Isı Büzüşmeli Ek Muflar (Bakır İletkenler İçin)	258,00	3x10
3FB 3-16		342,00	3x16
3FB 3-25		426,00	3x25
3FB 3-35		480,00	3x35
3FB 3-50		516,00	3x50
3FB 3-70		785,00	3x70
3FB 3-95		900,00	3x95
3FB 3-120		1128,00	3x120
3FB 3-150		1380,00	3x150
3FB 3-185		1620,00	3x185
3FB 3-240		1980,00	3x240

Stok Kodu	Model	Fiyat TL	Kablo Kesiti (mm ²)
3FA 3-16	Isı Büzüşmeli Ek Muflar (Alüminyum İletkenler İçin)	330,00	3x16
3FA 3-25		414,00	3x25
3FA 3-35		468,00	3x35
3FA 3-50		504,00	3x50
3FA 3-70		762,00	3x70
3FA 3-95		888,00	3x95
3FA 3-120		1104,00	3x120
3FA 3-150		1392,00	3x150
3FA 3-185		1596,00	3x185
3FA 3-240		1956,00	3x240

Stok Kodu	Model	Fiyat TL	Kablo Kesiti (mm ²)
3FB 4-10	Isı Büzüşmeli Ek Muflar (Bakır İletkenler İçin)	276,00	4x10
3FB 4-16		360,00	4x16
3FB 4-25		444,00	4x25
3FB 4-35		504,00	4x35
3FB 4-50		540,00	4x50
3FB 4-70		816,00	4x70
3FB 4-95		960,00	4x95
3FB 4-120		1188,00	4x120
3FB 4-150		1500,00	4x150
3FB 4-185		1800,00	4x185
3FB 4-240		2160,00	4x240

Stok Kodu	Model	Fiyat TL	Kablo Kesiti (mm ²)
3FA 4-16	Isı Büzüşmeli Ek Muflar (Alüminyum İletkenler İçin)	348,00	4x16
3FA 4-25		456,00	4x25
3FA 4-35		492,00	4x35
3FA 4-50		528,00	4x50
3FA 4-70		804,00	4x70
3FA 4-95		948,00	4x95
3FA 4-120		1164,00	4x120
3FA 4-150		1476,00	4x150
3FA 4-185		1776,00	4x185
3FA 4-240		2136,00	4x240



Stok Kodu	Model	Fiyat TL	Kablo Kesiti (mm ²)
3FB 5-10	Isı Büzüşmeli Ek Muflar (Bakır İletkenler İçin)	396,00	5x10
3FB 5-16		396,00	5x16
3FB 5-25		558,00	5x25
3FB 5-35		612,00	5x35
3FB 5-50		660,00	5x50
3FB 5-70		960,00	5x70
3FB 5-95		1152,00	5x95
3FB 5-120		1380,00	5x120
3FB 5-150		1980,00	5x150
3FB 5-185		2100,00	5x185
3FB 5-240		2580,00	5x240

Stok Kodu	Model	Fiyat TL	Kablo Kesiti (mm ²)
3FA 5-16	Isı Büzüşmeli Ek Muflar (Alüminyum İletkenler İçin)	384,00	5x16
3FA 5-25		546,00	5x25
3FA 5-35		600,00	5x35
3FA 5-50		648,00	5x50
3FA 5-70		948,00	5x70
3FA 5-95		1140,00	5x95
3FA 5-120		1356,00	5x120
3FA 5-150		1956,00	5x150
3FA 5-185		2076,00	5x185
3FA 5-240		2556,00	5x240

Stok Kodu	Model	Fiyat TL	Kablo Kesiti (mm ²)
3FB 3-16-10	Isı Büzüşmeli Ek Muflar (Bakır İletkenler İçin)	348,00	3x16+10
3FB 3-25-16		456,00	3x25+16
3FB 3-35-16		492,00	3x35+16
3FB 3-50-25		528,00	3x50+25
3FB 3-70-35		804,00	3x70+35
3FB 3-95-50		948,00	3x95+50
3FB 3-120-70		1164,00	3x120+70
3FB 3-150-70		1476,00	3x150+70
3FB 3-185-95		1776,00	3x185+95
3FB 3-240-120		2136,00	3x240+120

Stok Kodu	Model	Fiyat TL	Kablo Kesiti (mm ²)
3FA 3-16-10	Isı Büzüşmeli Ek Muflar (Alüminyum İletkenler İçin)	336,00	3x16+10
3FA 3-25-16		420,00	3x25+16
3FA 3-35-16		480,00	3x35+16
3FA 3-50-25		516,00	3x50+25
3FA 3-70-35		792,00	3x70+35
3FA 3-95-50		936,00	3x95+50
3FA 3-120-70		1140,00	3x120+70
3FA 3-150-70		1452,00	3x150+70
3FA 3-185-95		1752,00	3x185+95
3FA 3-240-120		2112,00	3x240+120

KLEMENSLER

GEÇMELİ BUAT KLEMENS

Stok Kodu	Model	Fiyat TL	Renk	Kablo Kesiti	Ebatlar (mm)			Ambalaj Adet	
					En	Boy	Yükseklik	Paket	Koli
4401	JW 2.5- 2	5,00	Beyaz	0.50- 2.5 mm ²	9,8	16,4	5,8	200	10.000
4402	JW2.5- 3	5,20	Turuncu	0.50- 2.5 mm ²	13,9	16,4	5,8	200	10.000
4403	JW2.5- 4	6,00	Kırmızı	0.50- 2.5 mm ²	17,9	16,4	5,8	100	5.000
4404	JW2.5- 5	6,95	Sarı	0.50- 2.5 mm ²	21,9	16,4	5,8	100	5.000
4405	JW2.5- 6	8,70	Kırmızı	0.50- 2.5 mm ²	13,8	16,4	11,25	100	5.000
4406	JW2.5- 8	9,90	Gri	0.50- 2.5 mm ²	17,8	16,4	11,25	100	5.000



ÇOK AMAÇLI KLEMENS

Stok Kodu	Model	Fiyat TL	Kablo Kesiti	Açıklama	Ambalaj Adet	
					Paket	Koli
4407	JW- 412	8,80	0.14- 4.0 mm ²	2 İletken Bağlantı	100	5.000
4408	JW- 413	11,75	0.14- 4.0 mm ²	3 İletken Bağlantı	100	5.000
4409	JW- 414	14,30	0.14- 4.0 mm ²	4 İletken Bağlantı	50	2.500
4410	JW- 415	17,15	0.14- 4.0 mm ²	5 İletken Bağlantı	50	2.500



→ Çalışma Sıcaklığı: -40°C ↔ 100°C
Nominal Akım: 32A
Nominal Gerilim: 450V

U KLEMENSLER

Stok Kodu	Model	Fiyat TL	Kutu Adeti	Koli Adeti
PWRU 006	6mm. U Klemens	30,00	300	1500
PWRU 010	10mm. U Klemens	40,50	250	1250
PWRU 016	16mm. U Klemens	54,00	125	625
PWRU 025	25mm. U Klemens	64,50	100	500
PWRU 035	35mm. U Klemens	69,00	75	375
PWRU 050	50mm. U Klemens	105,00	50	250
PWRU 070	70mm. U Klemens	129,00	40	200
PWRU 095	95mm. U Klemens	144,00	30	150
PWR 120	120mm. U Klemens	166,00	25	125
PWR 150	150mm. U Klemens	254,00	20	100



TIRNAKLI KLEMENSLER

Stok Kodu	Model	Fiyat TL	Kutu Adeti	Koli Adeti
PWR 25301	No.1 Tırnaklı Klemens (16 mm ²)	95,00	150	750
PWR 25302	No.2 Tırnaklı Klemens (25 mm ²)	145,00	100	500
PWR 25303	No.3 Tırnaklı Klemens (35 mm ²)	190,00	100	500
PWR 25304	No.4 Tırnaklı Klemens (50 mm ²)	330,00	50	250
PWR 25305	No.5 Tırnaklı Klemens (70 mm ²)	470,00	50	250
PWR 25306	No.6-7 Tırnaklı Klemens (95 mm ²)	570,00	30	150

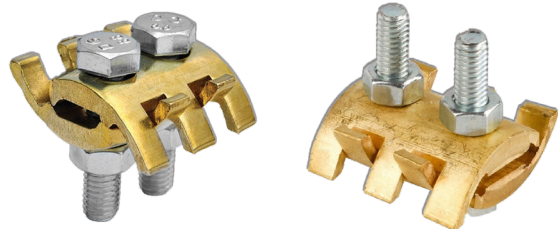

BARA SERFİLLERİ

Stok Kodu	Model	Fiyat TL	Koli Adeti
PWRS 08	Serfil M8	65,00	100
PWRS 10	Serfil M10	68,00	100

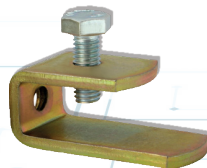

MESNET İZOLATÖRLER

M5 MİNİ İZOLATÖR 25 MM

Stok Kodu	Model	Fiyat TL	Kutu Adeti	Koli Adeti
PWR 05010	BMI-M 5/2C	19,60	100	1.500
PWR 05009	BMI-M 5/1C+ 1S	22,40	100	1.500
PWR 05023	BMI-M 5/2S	29,40	100	1.500

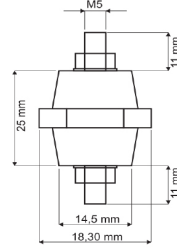

M6 ORTA BOY FIÇI İZOLATÖR 30 MM

Stok Kodu	Model	Fiyat TL	Kutu Adeti	Koli Adeti
PWR 050125	BMI-M 6/2C	27,00	150	500
PWR 05018	BMI-M 6/1C+ 1S	30,00	150	500
PWR 05011	BMI-M 6/2 S	34,20	150	500

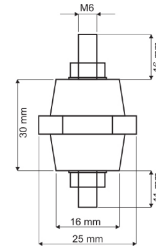

KONİK M6 ORTA BOY İZOLATÖR

Stok Kodu	Model	Fiyat TL	Kutu Adeti	Koli Adeti
PWR 05012	BMI-M 6/2C	25,20	50	500
PWR 05018	BMI-M 6/1C+ 1S	28,00	50	500
PWR 05011	BMI-M 2/2S	32,20	50	500

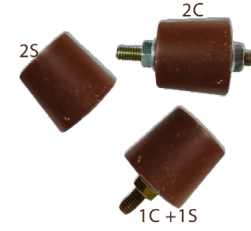
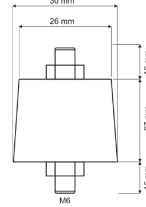

M8 BÜYÜK BOY FIÇI İZOLATÖR 35MM

Stok Kodu	Model	Fiyat TL	Kutu Adeti	Koli Adeti
PWR 05003	BMI-M 8/2C	43,40	50	250
PWR 05004	BMI-M 8/1C+ 1S	46,90	50	250
PWR 05005	BMI-M 8/2S	49,00	50	250

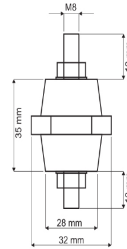

40 MM BÜYÜK BOY FIÇI İZOLATÖR (M10)

Stok Kodu	Model	Fiyat TL	Kutu Adeti	Koli Adeti
PWR 05007	BMI-M 10/2C	59,50	40	200
PWR 05008	BMI-M 10/1C+ 1S	63,00	40	200
PWR 05006	BMI-M 10/2S	154,70	40	250

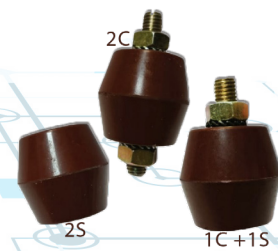
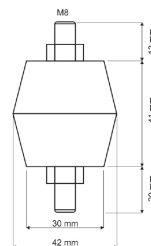

ÇİFT TARAF SAPMALI

Stok Kodu	Model	Fiyat TL	Ölçüler (mm)					Kullanım Voltajı (kV)	Test Voltajı (kV)	Gerilim Direnci (kN)	Ağırlık (kg)	Kutu Adeti
			A1	B1	B2	E	H					
PLSM 1001	1NO- S/M5	43,95	5	12	12	18	25,5	0,6	3	1,00	8,50	500
PLSM 1002	1N1-S/M6	60,00	6	16	16	21	29,5	0,6	3	1,00	8,70	300
PLSM 1003	1NMS-1/M8	104,85	8	15	15	31,5	40	1	3	4,00	7,10	100
PLSM 1004	1NMS-2/M10	117,84	10	15	15	31,5	40	1	3	4,00	9,50	100
PLSM 1013	1NMS-3/M8	255,84	8	18	18	43,5	50	1	3	4,00	9,50	100
PLSM 1014	1NMS- 4/M10	277,68	10	18	18	43,5	50	1	3	4,00	9,50	100



SAPMALI & KÖR SOMUNLU

Stok Kodu	Model	Fiyat TL	Ölçüler (mm)					Kullanım Voltajı (kV)	Test Voltajı (kV)	Gerilim Direnci (kN)	Ağırlık (kg)	Kutu Adeti
			A1	B1	B2	E	H					
PLSM 1005	1NO- K/M5	52,50	5	12	9	18	25,5	0,6	3	1,00	8,00	500
PLSM 1006	1N1-K/M6	74,85	6	16	12	21	29,5	0,6	3	1,00	7,50	300
PLSM 1007	1NMK-3/M8	125,55	8	15,5	15	31,5	40	1	3	4,00	5,80	100
PLSM 1008	1NMK-2/M10	143,10	10	15	15	31,5	40	1	3	4,00	7,70	100
PLSM 1015	1NMK-5/M8	229,65	8	18	15	43,5	50	1	3	4,00	7,70	100
PLSM 1016	1NMK- 6/M10	244,35	10	18	18	43,5	50	1	3	4,00	7,70	100

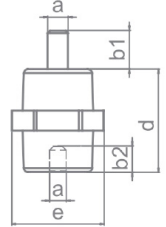

ÇİFT TARAF KÖR SOMUNLU

Stok Kodu	Model	Fiyat TL	Ölçüler (mm)					Kullanım Voltajı (kV)	Test Voltajı (kV)	Gerilim Direnci (kN)	Ağırlık (kg)	Kutu Adeti
			A1	B1	B2	E	H					
PLSM 1009	1NO- KK/M5	68,17	5	9	9	18	25,5	0,6	3	1,00	7,50	500
PLSM 1010	1N1-KK/M6	88,20	6	12	12	21	29,5	0,6	3	1,00	6,30	300
PLSM 1011	1NMK- 4/M8	125,40	8	15	15	31,5	40	1	3	4,00	4,60	100
PLSM 1012	1NMK- 1/M10	143,10	10	15	15	31,5	40	1	3	4,00	5,00	100
PLSM 1017	1NMK- 7/M8	229,65	8	15	15	43,5	50	1	3	4,00	5,00	100
PLSM 1018	1NMK- 8/M10	244,35	10	15	15	43,5	50	1	3	4,00	5,00	100

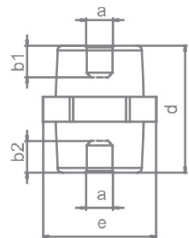

TARAK İZOLATÖRLER

Stok Kodu	Model	Fiyat TL	Kutu Adeti	Koli Adeti
PWR 05031	3 x 1 F Tarak İzolatör (Kısa Tip)	58,00	1	60

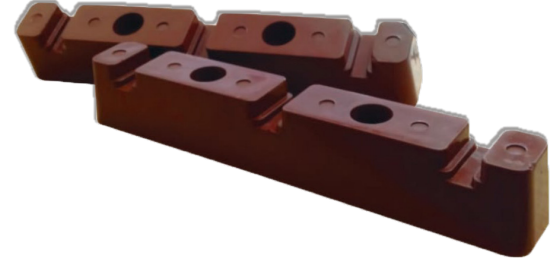
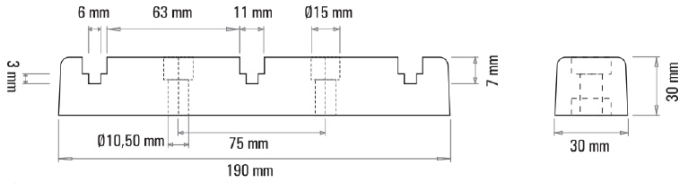

Stok Kodu	Model	Fiyat TL	Kutu Adeti	Koli Adeti
PWR 050311	3 x 1 F Tarak İzolatör (Uzun Tip)	60,00	1	30

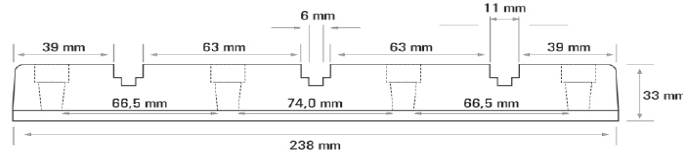

Stok Kodu	Model	Fiyat TL	Kutu Adeti	Koli Adeti
PWR 05032	3 x 2 F Tarak İzolatör	78,00	1	48

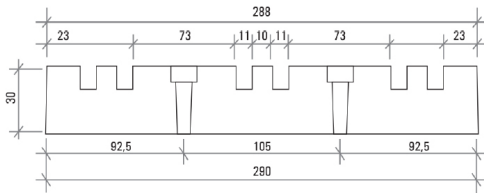

Stok Kodu	Model	Fiyat TL	Kutu Adeti	Koli Adeti
PWR 05034	3 x 1 F+N (4x1F) Tarak İzolatör	81,00	1	30

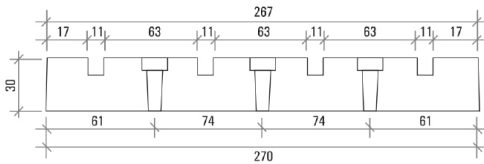

Stok Kodu	Model	Fiyat TL	Kutu Adeti	Koli Adeti
PWR 05035	3 x 2 F+ N Tarak İzolatör	108,00	1	30

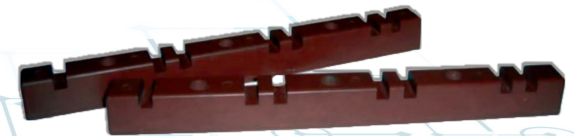
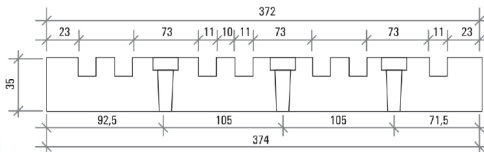

3X1F TARAK İZOLATÖR

Stok Kodu	Model	Fiyat TL	Ölçüler (mm)								Min. Direnç (kN)	Kutu Adeti
			A	C	D	E1	E2	F1	F2	H		
PLST 1001	3x 1F / 5-10mm	156,00	74	73	196	25	34,5	10,5	5,5	Ø8,5	5	50

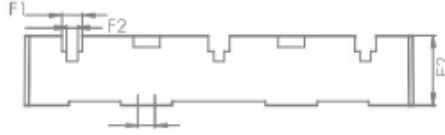
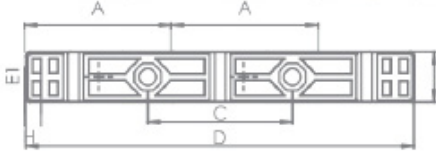

3X1F TARAK İZOLATÖR (4TİJ)

Stok Kodu	Model	Fiyat TL	Ölçüler (mm)									Min. Direnç (kN)	Kutu Adeti
			A	C1	C2	D	E1	E2	F1	F2	H		
PLST 1015	3x 1F / 5-10mm	165,00	74	74	58,14	220	25	35	10,5	5,5	Ø8,5	5	50

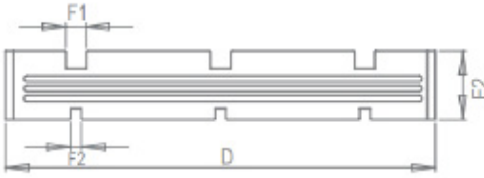
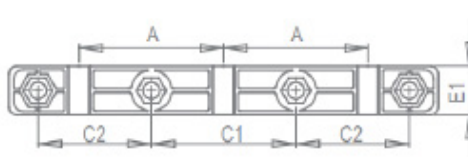

3X1 F+N TARAK İZOLATÖR

Stok Kodu	Model	Fiyat TL	Ölçüler (mm)								Min. Direnç (kN)	Kutu Adeti
			A	C	D	E1	E2	F1	F2	H		
PLST 1003	3x 1F+N/ 5-10mm	208,00	65	65	240	25,5	35,0	10,5	5,5	Ø9	5	50

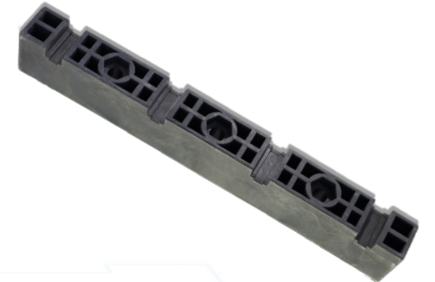
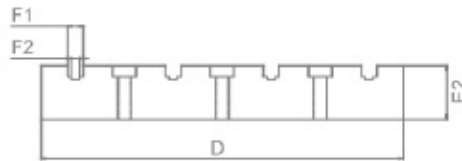
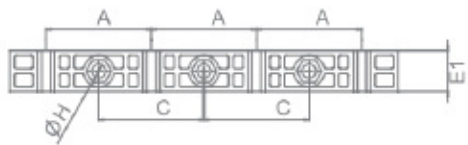

3X2F TARAK İZOLATÖR

Stok Kodu	Model	Fiyat TL	Ölçüler (mm)									Min. Direnç (kN)	Kutu Adeti
			A1	A2	C1	C2	D	E1	E2	F	H		
PLST 1002	3x 2F/10mm	260,00	20,5	81,3	80	105	290	25,0	34,5	10,5	Ø8,5	5	50

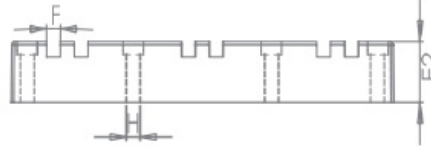
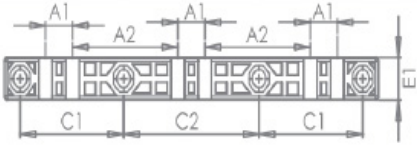

4X2F TARAK İZOLATÖR

Stok Kodu	Model	Fiyat TL	Ölçüler (mm)										Min. Direnç (kN)	Kutu Adeti
			A1	A2	C1	C2	D	E1	E2	F1	F2	H		
PLST 1016	4x 2F / 10mm 4x 2F / 5mm	540,00	31	64	85	85	340	25,0	35	10,5	5,5	Ø8,5	5	50

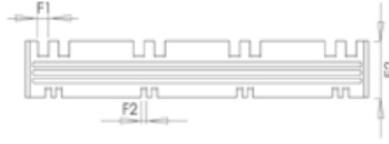
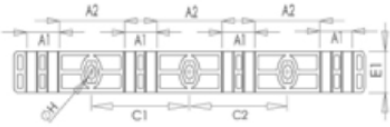

1X2F - 1X3F- 5-10 MM TARAK İZOLATÖR

Stok Kodu	Model	Fiyat TL	Ölçüler (mm)					Min. Direnç (kN)	Kutu Adeti
			A	D	H	E1	E2		
PLST 1012	1x 2F- 1x3F / 5-10mm	143,00	20,5	120	100	35	30	5	100

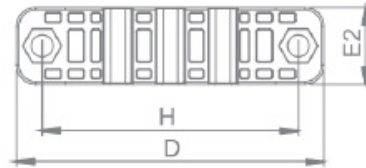
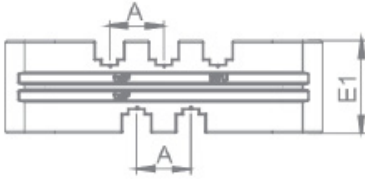

1X4F 10 MM TARAK İZOLATÖR (ALTI DÜZ TİP)

Stok Kodu	Model	Fiyat TL	Ölçüler (mm)								Min. Direnç (kN)	Kutu Adeti
			A	C	D	E1	E2	F1	F2			
PLST 1009	1x4 F/ 10mm	375,00	20,5	115	10,5	100	35	35	10	5	80	

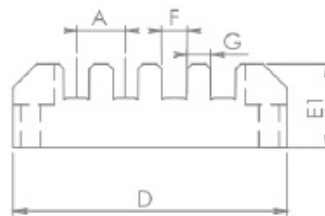
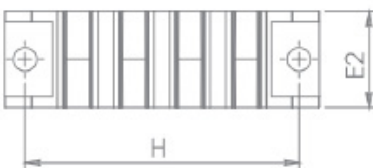

1X3F 5MM TARAK İZOLATÖR

Stok Kodu	Model	Fiyat TL	Ölçüler (mm)									Min. Direnç (kN)	Kutu Adeti
			A	C	C1	D	F	I	E1	E2	G		
PLST 1011	1x3F/ 5mm	143,00	10,5	25,0	8x12,4	65,0	5,5	50,0	30,0	37,0	5,0	5	100

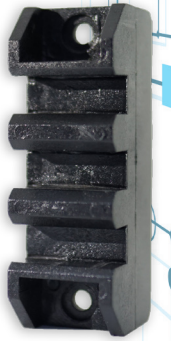
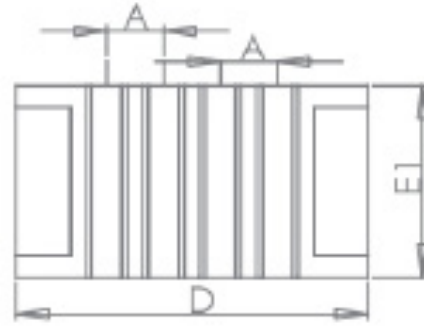
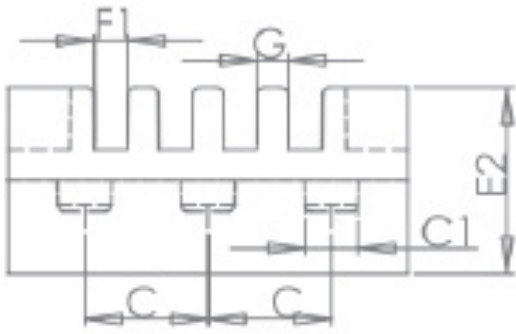

1X4F 5MM TARAK İZOLATÖR

Stok Kodu	Model	Fiyat TL	Ölçüler (mm)								Min. Direnç (kN)	Kutu Adeti
			A	C	C1	D	F1	E1	E2	G		
PLST 1005	1x4F/ 5mm	208,00	10,5	20,0	8	65,0	5,5	35,5	30	5,0	5	50

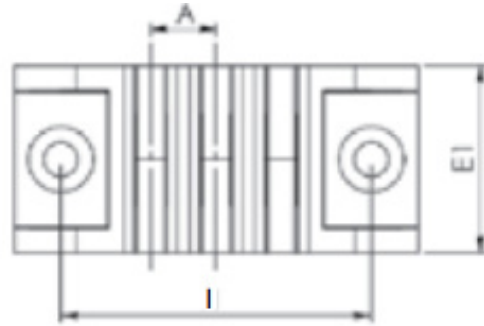
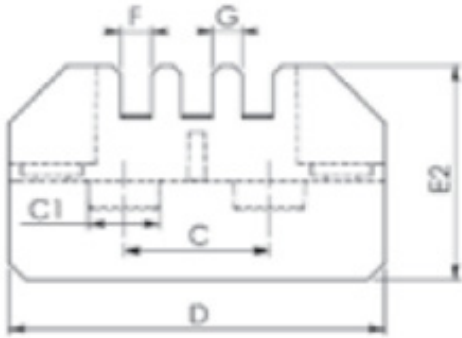

1x2F 10 MM TARAK İZOLATÖR (H:12mm)

Stok Kodu	Model	Fiyat TL	Ölçüler (mm)										Min. Direnç (kN)	Kutu Adeti
			A	C	C1	D	F	H	I	E1	E2	G		
PLST 1007	1x2F/ 10mm	131,00	20,5	25	8x12,4	65	10,5	12	50	30	37	Ø10	5	100

1x2F 10 MM TARAK İZOLATÖR (H:9,5mm)

Stok Kodu	Model	Fiyat TL	Ölçüler (mm)										Min. Direnç (kN)	Kutu Adeti
			A	C	C1	D	F	H	I	E1	E2	G		
PLST 1017	1x2F/ 10mm	131,00	20,5	25	8x12,4	65	10,5	9,5	50	30	33	Ø10	5	100

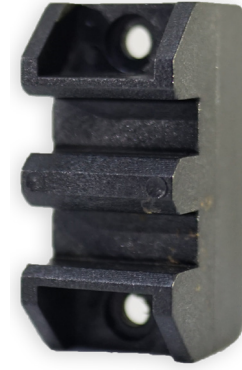
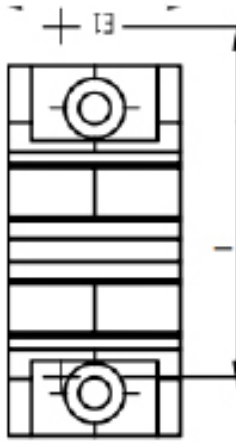
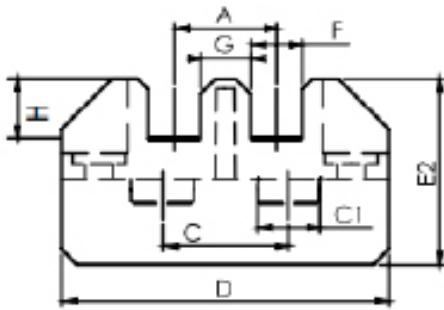

1x3F 10 MM TARAK İZOLATÖR (H:12mm)

Stok Kodu	Model	Fiyat TL	Ölçüler (mm)										Min. Direnç (kN)	Kutu Adeti
			A	C	C1	D	F	H	I	E1	E2	G		
PLST 1008	1x3F/ 10mm	151,00	20,5	20	8x12,4	90	10,5	12	75	30	37	Ø10	5	100

1x3F 10 MM TARAK İZOLATÖR (H:9,5mm)

Stok Kodu	Model	Fiyat TL	Ölçüler (mm)										Min. Direnç (kN)	Kutu Adeti
			A	C	C1	D	F	H	I	E1	E2	G		
PLST 1018	1x3F/ 10mm	151,00	20,5	20	8x12,4	90	10,5	9,5	75	30	33	Ø10	5	100

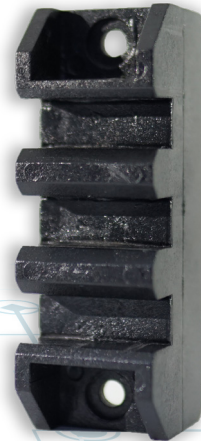
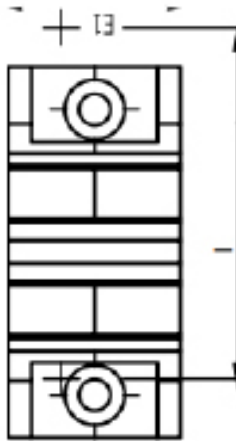
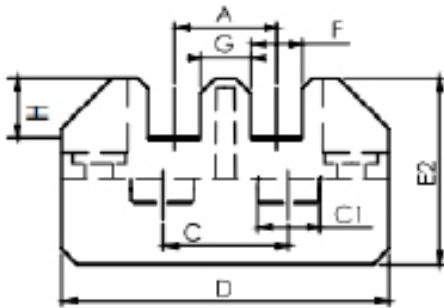

SIKMALI KABLO PABUÇLARI

STANDART TİP SIKMALI KABLO PABUCU

Stok Kodu	Kablo Kesiti (mm ²)	Delik Çapı (Ø)	Fiyat TL	Boyutlar(mm)						Kutu/ Amb. Adeti
				D	D1	D2	L	A	B	
PWRS 10-6	10	M6	16,00	6,5	4,4	6,3	29	12	11	750
PWRS 10-8	10	M8	16,00	8,5	4,4	6,3	33	12	13,5	750
PWRS 16-8	16	M8	20,00	8,5	5,5	7,5	33	12	13,5	400
PWRS 16-6	16	M6	20,00	6,5	5,5	7,0	32,5	11,0	10,5	400
PWRS 25-6	25	M6	31,59	6,5	7,0	9,0	38,5	16,0	13,0	350
PWRS 25-8	25	M8	31,59	8,5	7,0	9,0	38,5	16,0	13,0	350
PWRS 35-6	35	M6	43,00	6,5	8,5	10,5	43,5	19,0	15,5	200
PWRS 35-8	35	M8	43,00	8,3	8,5	10,5	43,5	19,0	15,5	200
PWRS 50-8	50	M8	68,81	8,5	10,0	12,0	51,5	21,0	17,6	150
PWRS 50-10	50	M10	68,81	10,5	10,0	12,0	51,5	21,0	17,6	150
PWRS 70-10	70	M10	88,17	10,5	11,5	14,0	55,5	23,0	20,7	100
PWRS 70-12	70	M12	88,17	13,0	11,5	14,0	55,5	23,0	20,7	100
PWRS 95-10	95	M10	95,68	10,5	13,5	16,0	58,5	26,0	23,5	75
PWRS 95-12	95	M12	95,68	13,0	13,5	16,0	58,5	26,0	23,5	75
PWRS 120-10	120	M10	136,56	10,5	15,5	18,0	71,0	29,0	26,7	50
PWRS 120-12	120	M12	233,97	13,0	15,5	18,0	71,0	29,0	26,7	50
PWRS 150-10	150	M10	208,61	10,5	16,5	20,0	76,0	30,0	29,2	40
PWRS 150-12	150	M12	207,57	13,0	16,5	20,0	76,0	30,0	29,2	40
PWRS 185-12	185	M12	238,70	13,0	18,5	22,0	82,0	33,0	32,3	30
PWRS 185-16	185	M16	238,70	17,0	18,5	22,0	82,0	33,0	32,3	30
PWRS 240-12	240	M12	322,57	13,0	21,5	25,5	91,0	38,0	37,6	25
PWRS 240-16	240	M16	322,57	17,0	21,5	25,5	91,0	38,0	37,6	25



EK MUF BAKIR

Stok Kodu	Kablo Kesiti (mm ²)	Fiyat TL	D	D1	L	Kutu Adeti
PWREEM16	16	16,00	5,5	7,8	32	400
PWREEM 25	25	22,35	12	6	55	300
PWREEM 35	35	32,25	13	8	60	200
PWREEM 50	50	35,90	16	10	74	150
PWREEM 70	70	59,34	18	12	80	100
PWREEM 95	95	69,24	20	14	86	75
PWREEM 120	120	98,95	23	15	101	50
PWREEM 150	150	148,46	24	16	105	40
PWREEM 185	165	186,24	18,5	23	86	22
PWREEM 240	240	258,06	21	26	94	18

TAM EKONOMİK TİP SIKMALI KABLO PABUCU

Stok Kodu	Kablo Kesiti (mm ²)	Fiyat TL	Uzunluk (L) mm	Kutu/ Amb. Adeti
PWRE 16-6	16 M6	11,10	32,50	600
PWRE 16-8	16 M8	13,25	32,50	600
PWRE 25-8	25 M8	19,20	38,50	400
PWRE 35-8	35 M8	26,45	43,50	300
PWRE 50-10	50 M10	33,32	51,50	200
PWRE 70-10	70 M10	51,61	55,50	125
PWRE 95-12	95 M12	63,02	58,50	100
PWRE 120-12	120 M12	92,47	71,00	60
PWRE 150-12	150 M12	126,87	76,00	50
PWRE 185-16	185 M16	163,43	82,00	40
PWRE 240-16	240 M16	235,98	89,00	40



BİMETALİK SIKMALI KABLO PAPAÇLARI

Stok Kodu	Model	Kablo Kesiti (mm ²)	Delik Çapı Ø	Fiyat \$	Ebatlar (mm)		Koli Adeti
					D	L	
7360	JBM 16	16	M12	2,10 \$	13.0	84.0	50
7361	JBM 25	25	M12	2,10 \$	13.0	84.0	50
7362	JBM 35	35	M12	2,10 \$	13.0	84.0	50
7363	JBM 50	50	M12	3,00 \$	13.0	84.0	30
7364	JBM 70	70	M12	3,00 \$	13.0	84.0	30
7365	JBM 95	95	M12	3,00 \$	13.0	84.0	30
7366	JBM 120	120	M12	5,00 \$	13.0	107.0	25
7367	JBM 150	150	M12	5,00 \$	13.0	107.0	25
7368	JBM 185	185	M12	8,20 \$	13.0	117.0	20
7369	JBM 240	240	M12	8,20 \$	13.0	117.0	20
7370	JBM 300	300	M16	11,75 \$	17.0	135.0	15
7371	JBM 400	400	M16	15,30 \$	17.0	135.0	15



ALÜMİNYUM SIKMALI KABLO PABUCU

Stok Kodu	Kablo Kesiti (mm ²)	Delik Çapı Ø	Fiyat TL	İç Çap	Dış Çap	Uzunluk	Paket Adeti
PWRAS 16	16	6	12,15	5,6	10	60	250
PWRAS 25	25	8	16,20	7	12	70	150
PWRAS 35	35	8	20,25	8,2	14	76	100
PWRAS 50	50	10	27,00	10	16	83	80
PWRAS 70	70	12	40,50	11,40	18	97	60
PWRAS 95	95	12	50,55	13,40	22	109	40
PWRAS 120	120	12	57,30	15	22	109	40
PWRAS 150	150	12	81,00	16,50	26	118,5	25
PWRAS 185	185	12	108,00	18,50	28	125,5	20
PWRAS 240	240	12	135,00	21,2	32	141,5	14

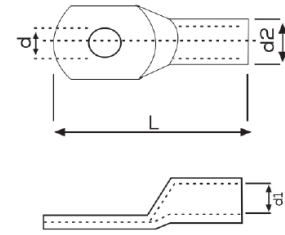

ALÜMİNYUM SIKMALI EK MUFLAR

Stok Kodu	Kablo Kesiti (mm ²)	Fiyat TL	Paket Adeti
PWRAEM 16	16	12,00	250
PWRAEM 25	25	13,50	150
PWRAEM 35	35	18,90	100
PWRAEM 50	50	27,00	80
PWRAEM 70	70	33,75	60
PWRAEM 95	95	47,25	40
PWRAEM 120	120	50,70	40
PWRAEM 150	150	78,00	25
PWRAEM 185	185	96,00	20
PWRAEM 240	240	123,00	14



İZOLELİ KABLO YÜKSÜKLERİ FRANSIZ NORMU

Stok Kodu	Model	Fiyat TL	Renk	Kablo Kesiti (mm ²)	Ebatlar (mm)					Paket Adeti
					F	L	W	B	D	
3801	JYF- 0.25	0,65	Menekşe	0.25	8.0	12.0	1.9	4.4	1.1	1000
3802	JYF- 0.34	0,65	Pembe	0.34	8.0	12.0	1.9	4.4	1.1	1000
3803	JYF- 0.50	0,29	Beyaz	0.50	8.0	14.0	2.6	6.0	1.3	1000
3804	JYF- 0.75	0,29	Mavi	0.75	8.0	14.0	2.8	6.3	1.5	1000
3805	JYF- 1.0	0,29	Kırmızı	1.00	8.0	14.0	3.0	6.3	1.7	1000
3806	JYF- 1.5	0,32	Siyah	1.50	8.0	14.0	3.5	6.3	2.0	1000
3807	JYF- 2.5	0,41	Gri	2.50	8.0	14.0	4.2	7.4	2.5	500
3808	JYF- 4.0	0,69	Turuncu	4.00	10.0	17.0	4.8	7.4	3.2	500
3809	JYF- 6.0	0,93	Yeşil	6.00	12.0	20.0	6.3	8.5	3.9	250
3810	JYF- 10.0	1,18	Kahve	10.0	12.0	20.0	6.3	8.5	3.9	100
3811	JYF- 16.0	1,64	Bej	16.0	12.0	24.0	8.8	10.0	6.2	100
3812	JYF- 25.0	2,75	Siyah	25.0	16.0	28.0	11.2	12.0	7.7	50
3813	JYF- 35.0	3,42	Kırmızı	35.0	16.0	30.0	12.7	14.0	8.7	50
3814	JYF- 50.0	6,48	Mavi	50.0	20.0	36.0	15.0	16.0	10.9	25
3815	JYF- 70.0	12,00	Sarı	70.0	21.0	37.0	16.0	17.0	14.3	25
3830	JYF- 95.0	12,70	Kırmızı	95.0	20.0	36.0	15.0	16.0	10.9	25

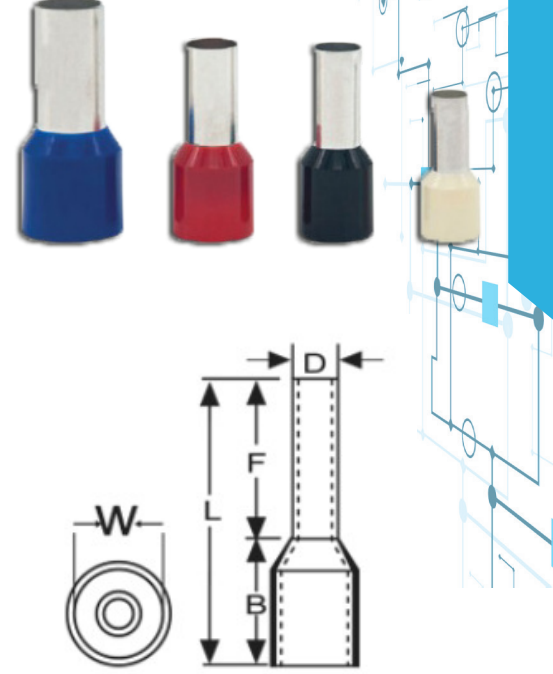

→ STANDART: DIN 46228
MALZEME: Bakır, Kalay Kaplı
İZOLASYON: Naylon
ÇALIŞMA SICAKLIĞI: Maksimum 105° 600 Volt Arası

ÇİFT GİRİŞLİ KABLO YÜKSÜKLERİ FRANSIZ NORMU

Stok Kodu	Model	Fiyat TL	Renk	Kablo Kesiti (mm ²)	Ebatlar (mm)					Paket Adeti
					F	L	W	B	D	
3831	JCY- 0.50F	0,59	Beyaz	0.50	8.0	14.0	5.0	6.5	1.8	1000
3832	JCY- 0.75F	0,62	Mavi	0.75	8.0	14.0	5.5	6.7	2.1	500
3833	JCY- 1.0F	0,69	Kırmızı	1.00	8.0	14.0	5.5	7.1	2.4	500
3834	JCY- 1.5F	0,82	Siyah	1.50	8.0	14.0	6.4	7.5	2.6	500
3835	JCY- 2.5F	1,35	Gri	2.50	10.0	14.0	8.0	8.5	3.3	250
3836	JCY- 4.0F	1,71	Turuncu	4.00	12.0	17.0	8.0	11.1	4.2	200
3837	JCY- 6.0F	1,95	Yeşil	6.00	14.0	20.0	9.5	12.1	5.3	100
3838	JCY- 10.0F	2,90	Kahve	10.0	14.0	27.0	12.6	12.6	6.9	50
3839	JCY- 16.0F	3,80	Bej	16.0	14.0	31.0	19.0	17.3	8.7	50

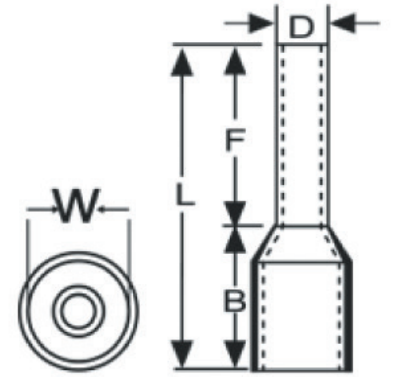

→ STANDART: DIN 46228
MALZEME: Bakır, Kalay Kaplı
İZOLASYON: Naylon
ÇALIŞMA SICAKLIĞI: Maksimum 105° 600 Volt Arası



YUVARLAK TİP İZOLELİ KABLO UÇLARI

Stok Kodu	Model	Fiyat TL	Renk	Kablo Kesiti (mm ²)	Civata Ölçüsü	Ebatlar (mm)						Kutu Adeti
						D2	D3	L	D1	D4	A	
3901	JYU-301	1,03	Kırmızı	0.50- 1.50	M3	3.2	6.0	16.0	1.6	4.0	10.0	200
3902	JYU- 401	1,54	Kırmızı		M4	4.3	8.0	17.0	1.6	4.0	10.0	200
3903	JYU- 501	1,56	Kırmızı		M5	5.3	10.0	18.0	1.6	4.0	10.0	200
3904	JYU- 601	2,47	Kırmızı		M6	6.5	10.0	18.0	1.6	4.0	10.0	200
3905	JYU- 801	2,47	Kırmızı		M8	8.4	14.0	22.0	1.6	4.0	10.0	200

Stok Kodu	Model	Fiyat TL	Renk	Kablo Kesiti (mm ²)	Civata Ölçüsü	Ebatlar (mm)						Kutu Adeti
						D2	D3	L	D1	D4	A	
3906	JYU- 302	1,91	Mavi	1.50- 2.50	M3	3.2	6.0	16.0	2.3	4.5	10.0	200
3907	JYU- 402	1,91	Mavi		M4	4.3	8.0	17.0	2.3	4.5	10.0	200
3908	JYU- 502	1,96	Mavi		M5	5.3	10.0	19.0	2.3	4.5	10.0	200
3910	JYU- 602	2,75	Mavi		M6	6.5	11.0	20.0	2.3	4.5	10.0	200
3911	JYU- 802	2,75	Mavi		M8	8.4	14.0	22.0	2.3	4.5	10.0	200
3912	JYU- 1002	2,90	Mavi		M10	10.5	15.0	22.0	2.3	4.5	10.0	200

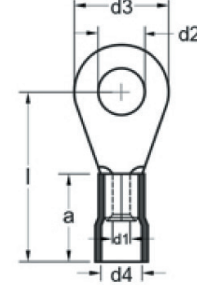

STANDART: DIN 46228
MALZEME: Bakır, Kalay Kaplı

Stok Kodu	Model	Fiyat TL	Renk	Kablo Kesiti (mm ²)	Civata Ölçüsü	Ebatlar (mm)						Kutu Adeti
						D2	D3	L	D1	D4	A	
3913	JYU- 406	4,07	Sarı	4.00- 6.00	M4	4.3	8.6	21.0	3.6	6.3	13.0	100
3914	JYU- 506	4,07	Sarı		M5	5.3	10.0	22.0	3.6	6.3	13.0	100
3915	JYU- 606	4,62	Sarı		M6	6.5	11.0	22.5	3.6	6.3	13.0	100
3916	JYU- 806	5,94	Sarı		M8	8.4	14.0	26.0	3.6	6.3	13.0	100
3917	JYU- 1006	5,397	Sarı		M10	10.5	18.0	28.0	3.6	6.3	13.0	100
3918	JYU- 1206	6,05	Sarı		M12	13.0	18.0	28.0	3.6	6.3	13.0	100



Stok Kodu	Model	Fiyat TL	Renk	Kablo Kesiti (mm ²)	Civata Ölçüsü	Ebatlar (mm)						Kutu Adeti
						D2	D3	L	D1	D4	A	
3919	JYU- 610	6,60	Kırmızı	8.00- 10.00	M6	6.7	23.5	30.0	4.5	8.0	17.0	50
3920	JYU- 810	8,25	Kırmızı		M8	8.4	26.3	36.0	4.5	8.0	17.0	50

ÇATAL TİP İZOLELİ KABLO UÇLARI

Stok Kodu	Model	Fiyat TL	Renk	Kablo Kesiti (mm ²)	Civata Ölçüsü	Ebatlar (mm)						Kutu Adeti
						D2	D3	L	D1	D4	A	
3921	JÇU-3001	1,40	Kırmızı	0.50- 1.50	M3	3.2	6.0	16.0	1.6	4.0	10.0	200
3922	JÇU- 4001	1,45	Kırmızı		M4	4.3	8.0	17.0	1.6	4.0	10.0	200
3923	JÇU- 5001	1,50	Kırmızı		M5	5.3	10.0	18.0	1.6	4.0	10.0	200
3924	JÇU- 6001	1,70	Kırmızı		M6	6.5	11.0	20.0	1.6	4.0	10.0	200

Stok Kodu	Model	Fiyat TL	Renk	Kablo Kesiti (mm ²)	Civata Ölçüsü	Ebatlar (mm)						Kutu Adeti
						D2	D3	L	D1	D4	A	
3925	JÇU- 3002	1,58	Mavi	2.50-4.00	M3	3.2	5.5	18.0	2.3	4.5	10.0	200
3926	JÇU- 4002	1,62	Mavi		M4	4.3	6.8	17.0	2.3	4.5	10.0	200
3927	JÇU- 5002	1,65	Mavi		M5	5.3	10.0	19.0	2.3	4.5	10.0	200
3928	JÇU- 6002	2,20	Mavi		M6	6.5	11.0	21.0	2.3	4.5	10.0	200

Stok Kodu	Model	Fiyat TL	Renk	Kablo Kesiti (mm ²)	Civata Ölçüsü	Ebatlar (mm)						Kutu Adeti
						D2	D3	L	D1	D4	A	
3929	JÇU- 4006	3,57	Sarı	4.00- 6.00	M4	4.3	8.0	21.0	3.6	13.0	13.0	100
3930	JÇU- 5006	3,63	Sarı		M5	5.3	10.0	22.0	3.6	6.3	13.0	100
3931	JÇU- 6006	4,84	Sarı		M6	6.5	11.0	23.0	3.6	6.3	13.0	100
3932	JÇU- 8006	5,66	Sarı		M8	8.4	14.0	26.0	3.6	6.3	13.0	100

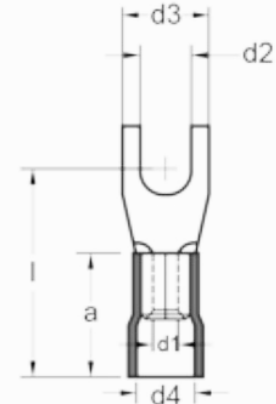











STANDART: DIN 46228
MALZEME: Bakır, Kalay Kaplı





İZOLESİZ KABLO UCU VE KONNEKTÖRLERİ

					
Stok Kodu	4001	4002	4003	4004	4005
Model	JF1/ 2D	JF1D MİNİ	JF1D	JF3D	JF2D TRK
Fiyat TL	0,77	0,96	1,18	3,42	1,18
Açıklama	2.8 Mikro Dişi Terminal	4.8 Mini Dişi Terminal	6.3 Dişi Terminal	9.5 Dişi Terminal	6.3 Tırnaklı Dişi Terminal
Kutu Adeti	1000	500	300	100	300

					
Stok Kodu	4006	4007	4008	4009	4010
Model	JF1D EĞRİ	JF1D E	JKN 1-03	JKN 1-04	JKN 2.5- 04
Fiyat TL	1,54	2,98	1,13	1,13	1,14
Açıklama	6.3 Eğri Dişi Terminal	6.3 Erkek Geri Dönüşümlü Terminal	M3 Topraklama Terminal	M4 Topraklama Terminal	M4 Topraklama Terminal
Kutu Adeti	250	200	500	500	500

					
Stok Kodu	4011	4012	4013	4014	4015
Model	JKN 2.5- 05	JKN 2.5- 06	JKN 4-04	JKN 4-05	JKN 4- 06
Fiyat TL	1,15	1,15	2,18	2,18	2,18
Açıklama	M5 Topraklama Terminal	M6 Topraklama Terminal	M4 Topraklama Terminal	M5 Topraklama Terminal	M6 Topraklama Terminal
Kutu Adeti	500	500	250	250	250

					
Stok Kodu	4016	4017	4018	4019	4020
Model	JKN 6- 06	JKN 8- 08	JKN 10- 10	JK 2.5	JK 4
Fiyat TL	3,41	3,41	3,85	1,10	1,92
Açıklama	M6 Topraklama Terminal	M8 Topraklama Terminal	M10 Topraklama Terminal	Boru Tip Topraklama Terminal	Boru Tip Topraklama Terminal
Kutu Adeti	150	150	100	1000	500

					
Stok Kodu	4021	4022	4023	4024	4025
Model	JK 6	JF1 E ÇEK	JF1 EU1	R TİPİ KONNEKTÖR	JF1D KILIF
Fiyat TL	2,53	1,22	1,51	0,88	0,65
Açıklama	M6 Topraklama Terminal	M8 Topraklama Terminal	M10 Topraklama Terminal	Boru Tip Topraklama Terminal	Boru Tip Topraklama Terminal
Kutu Adeti	250	300	300	300	300

TOPRAKLAMA KLEMENSLERİ

PANO TOPRAKLAMA KLEMENSLERİ AYAKLI (6,5x9 mm Kesit 80A)

Stok Kodu	Model	Fiyat TL	L	L2	H	Koli Adeti
NK 08006	6. Delikli Topraklama Klemensi	53,00	85	70	22	200
NK 08007	7. Delikli Topraklama Klemensi	58,00	90	75	22	200
NK 08010	10. Delikli Topraklama Klemensi	71,00	108	95	22	150
NK 08012	12. Delikli Topraklama Klemensi	75,00	120	106	22	150
NK 08015	15. Delikli Topraklama Klemensi	90,00	138	124	22	125
NK 08020	20. Delikli Topraklama Klemensi	117,00	165	152	22	100
NK 08025	25. Delikli Topraklama Klemensi	150,00	195	180	22	75
NK 08030	30. Delikli Topraklama Klemensi	222,00	235	220	22	75

→ 30 Delikten sonrası delik adet fiyatı : 4.00 TL



PANO TOPRAKLAMA KLEMENSLERİ AYAKSIZ (6,5x9 mm Kesit 80A)

Ürün Kodu	Model	Fiyat TL	L	L2	B	H	Koli Adeti
ATK 08006	6. Delikli Topraklama Klemensi	48,00	52	44	6,5	9	500
ATK 08007	7. Delikli Topraklama Klemensi	54,00	57	49	6,5	9	500
ATK 08010	10. Delikli Topraklama Klemensi	66,00	76	68	6,5	9	400
ATK 08012	12. Delikli Topraklama Klemensi	69,00	88	80	6,5	9	400
ATK 08015	15. Delikli Topraklama Klemensi	88,00	105	97	6,5	9	250
ATK 08020	20. Delikli Topraklama Klemensi	114,00	134	126	6,5	9	250
ATK 08025	25. Delikli Topraklama Klemensi	153,00	165	155	6,5	9	100
ATK 08030	30. Delikli Topraklama Klemensi	214,00	194	185	6,5	9	100

→ 30 Delikten sonrası delik adet fiyatı : 4.00TL

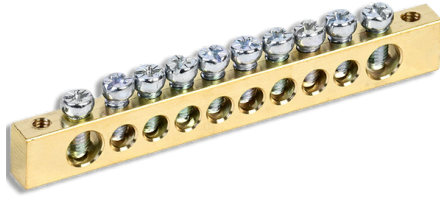

PANO TOPRAKLAMA KLEMENSLERİ AYAKLI (7X12 KESİT- 125 AMPER- AYAKLI)

Stok Kodu	Model	Fiyat TL	L	L2	H	Koli Adeti
NK 12506	6. Delikli Topraklama Klemensi	71,00	77	63	22	200
NK 12507	7. Delikli Topraklama Klemensi	75,00	87	72	22	200
NK 12510	10. Delikli Topraklama Klemensi	87,00	110	91	22	125
NK 12512	12. Delikli Topraklama Klemensi	105,00	124	116	22	125
NK 12515	15. Delikli Topraklama Klemensi	138,00	146	132	22	100
NK 12520	20. Delikli Topraklama Klemensi	166,00	182	165	22	100
NK 12525	25. Delikli Topraklama Klemensi	222	217	203	22	80
NK 12530	30. Delikli Topraklama Klemensi	294,00	265	252	22	75

→ 30 Delikten sonrası delik adet fiyatı : 4.00 TL

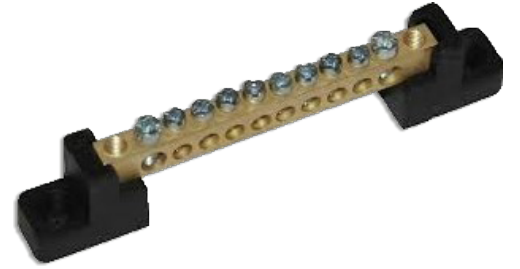

PANO TOPRAKLAMA KLEMENSLERİ AYAKSIZ (7X12 KESİT- 125 AMPER)

Stok Kodu	Model	Fiyat TL	L	L2	H	Koli Adeti
TK 12506	6. Delikli Topraklama Klemensi	70,00	63	55	175	200
TK 12507	7. Delikli Topraklama Klemensi	74,00	69	61	175	200
TK 12510	10. Delikli Topraklama Klemensi	86,00	94	84	100	150
TK 12512	12. Delikli Topraklama Klemensi	104,00	119	100	100	150
TK 12515	15. Delikli Topraklama Klemensi	137,00	130	121	100	150
TK 12520	20. Delikli Topraklama Klemensi	165,00	165	157	100	150
TK 12525	25. Delikli Topraklama Klemensi	226,00	203	198	75	100
TK 12530	30. Delikli Topraklama Klemensi	293,00	235	226	50	100

→ 30 Delikten sonrası delik adet fiyatı : 4.00 TL

PANO TOPRAKLAMA KLEMENSİ NÖTR AYAKLI (6X8 mm 63 A)

Stok Kodu	Model	Fiyat TL	Kutu Adeti
PWR NK 06304	4 Delikli Topraklama Klemensi	29,59	500
PWR NK 06305	5 Delikli Topraklama Klemensi	37,00	500
PWR NK 06306	6 Delikli Topraklama Klemensi	45,00	400
PWR NK 06307	7 Delikli Topraklama Klemensi	48,00	400
PWR NK 06308	8 Delikli Topraklama Klemensi	52,00	300
PWR NK 06310	10 Delikli Topraklama Klemensi	64,00	300
PWR NK 06312	12 Delikli Topraklama Klemensi	69,00	250
PWR NK 06314	14 Delikli Topraklama Klemensi	78,00	250
PWR NK 06315	15 Delikli Topraklama Klemensi	83,00	250
PWR NK 06316	16 Delikli Topraklama Klemensi	89,00	250
PWR NK 06318	18 Delikli Topraklama Klemensi	95,00	250
PWR NK 06320	20 Delikli Topraklama Klemensi	100,00	200



PANO TOPRAKLAMA KLEMENSİ AYAKSIZ (6X8 mm 63A)

Stok Kodu	Model	Fiyat TL	Kutu Adeti
PWR TK 06404	4 Delikli Topraklama Klemensi	27,00	500
PWR TK 06405	5 Delikli Topraklama Klemensi	33,00	500
PWR TK 06406	6 Delikli Topraklama Klemensi	40,00	450
PWR TK 06407	7 Delikli Topraklama Klemensi	42,00	450
PWR TK 06408	8 Delikli Topraklama Klemensi	48,00	450
PWR TK 06410	10 Delikli Topraklama Klemensi	59,00	400
PWR TK 06412	12 Delikli Topraklama Klemensi	63,00	400
PWR TK 06414	14 Delikli Topraklama Klemensi	75,00	400
PWR TK 06415	15 Delikli Topraklama Klemensi	80,00	350
PWR TK 06416	16 Delikli Topraklama Klemensi	85,00	350
PWR TK 06418	18 Delikli Topraklama Klemensi	92,00	350
PWR TK 06420	20 Delikli Topraklama Klemensi	103,00	300



PANO TOPRAKLAMA KLEMENSLERİ (6x8 mm Kesit 63A)

Stok Kodu	Model	Fiyat TL	B	H	L	Koli Adeti
TK 06304	4. Delikli Topraklama Klemensi	22,00	6	8	33	1.500
TK 06305	5. Delikli Topraklama Klemensi	24,00	6	8	38	1.500
TK 06306	6. Delikli Topraklama Klemensi	29,00	6	8	45	1.250
TK 06307	7. Delikli Topraklama Klemensi	33,00	6	8	50	1000
TK 06309	9. Delikli Topraklama Klemensi	36,00	6	8	62	1000
TK 06310	10. Delikli Topraklama Klemensi	45,00	6	8	68	800
TK 06312	12. Delikli Topraklama Klemensi	54,00	6	8	80	600
TK 06315	15. Delikli Topraklama Klemensi	68,00	6	8	98	500



DAĞITICI ÜNİTELER

1 KUTUP DAĞITICI ÜNİTELER RAY GEÇMELİ KAPAKSIZ (7 × 12 mm 125 AMPER)

Stok Kodu	Model	Fiyat TL	L	B	H	Koli Adeti
DU 125107	2+5 7 Delikli Dağıtım Ünitesi	90,00	76	44	42	80
DU 125110	2+8 10 Delikli Dağıtım Ünitesi	96,00	100	44	42	75
DU 125112	2+10 12 Delikli Dağıtım Ünitesi	114,00	115	44	42	60
DU 125115	2+13 15 Delikli Dağıtım Ünitesi	138,00	135	44	42	50
DU 125120	2+18 20 Delikli Dağıtım Ünitesi	186,00	170	44	42	40
DU 125122	2+20 22 Delikli Dağıtım Ünitesi	216,00	185	44	42	40
DU 125125	2+23 25 Delikli Dağıtım Ünitesi	246,00	207	44	42	30
DU 125130	2+28 30 Delikli Dağıtım Ünitesi	296,00	145	44	42	25

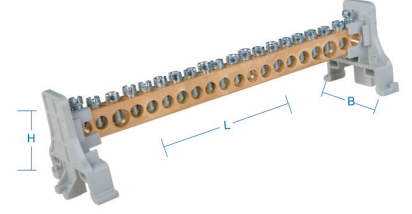

1 KUTUP DAĞITICI ÜNİTELER RAY GEÇMELİ KAPAKLI (7 × 12 mm 125 AMPER)

Stok Kodu	Model	Fiyat TL	L	B	H	Koli Adeti
DU 125107	2+5 7 Delikli Dağıtım Ünitesi	102,00	76	44	42	70
DU 125110	2+8 10 Delikli Dağıtım Ünitesi	132,00	100	44	42	60
DU 125112	2+10 12 Delikli Dağıtım Ünitesi	156,00	115	44	42	35
DU 125115	2+13 15 Delikli Dağıtım Ünitesi	192,00	135	44	42	45
DU 125120	2+18 20 Delikli Dağıtım Ünitesi	228,00	170	44	42	35
DU 125122	2+20 22 Delikli Dağıtım Ünitesi	237,00	185	44	42	35
DU 125125	2+23 25 Delikli Dağıtım Ünitesi	252	207	44	42	20
DU 125130	2+28 30 Delikli Dağıtım Ünitesi	303,00	145	44	42	20

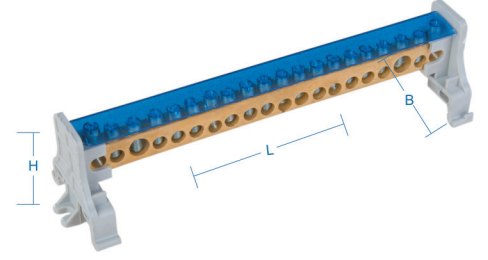

2 KUTUPLU DAĞITICI ÜNİTESİ (6,5x9 mm 80A)

Stok Kodu	Model	Fiyat TL	L	B	H	Koli Adeti
DU 80207	2+5 7 Delikli Dağıtım Ünitesi	204,00	63	45	47	22
DU 80210	2+8 10 Delikli Dağıtım Ünitesi	240,00	83	45	47	15
DU 80212	2+10 12 Delikli Dağıtım Ünitesi	264,00	94	45	47	14
DU 80215	2+13 15 Delikli Dağıtım Ünitesi	348,00	110	45	47	12
DU 80220	2+18 20 Delikli Dağıtım Ünitesi	456,00	140	45	47	6
DU 80222	2+20 22 Delikli Dağıtım Ünitesi	480,00	151	45	47	6



2 KUTUPLU DAĞITICI ÜNİTESİ (7x12 mm 125A)

Stok Kodu	Model	Fiyat TL	L	B	H	Koli Adeti
DU 125207	2+5 7 Delikli Dağıtım Ünitesi	234,00	65	45	47	22
DU 125210	2+8 10 Delikli Dağıtım Ünitesi	260,00	88	45	47	15
DU 125212	2+10 12 Delikli Dağıtım Ünitesi	288,00	102	45	47	14
DU 125215	2+13 15 Delikli Dağıtım Ünitesi	372,00	126	45	47	12
DU 125220	2+18 20 Delikli Dağıtım Ünitesi	480,00	162	45	47	6
DU 125222	2+20 22 Delikli Dağıtım Ünitesi	516,00	175	45	47	6



3 KUTUPLU DAĞITICI ÜNİTESİ (6,5x 9mm 80A)

Stok Kodu	Model	Fiyat TL	L	B	H	Koli Adeti
DU 80307	2+5 7 Delikli Dağıtım Ünitesi	411,00	117,00	55	50,8	12
DU 80310	2+8 10 Delikli Dağıtım Ünitesi	432,00	154,5	55	50,8	8
DU 80312	2+10 12 Delikli Dağıtım Ünitesi	495,00	179,00	55	50,8	8
DU 80315	2+13 15 Delikli Dağıtım Ünitesi	594,00	217,00	55	50,8	6
DU 80320	2+18 20 Delikli Dağıtım Ünitesi	748,00	280,00	55	50,8	4
DU 80322	2+20 22 Delikli Dağıtım Ünitesi	768,00	304,5	55	50,8	4
DU 80325	2+23 25 Delikli Dağıtım Ünitesi	874,00	360,00	55	50,8	4

3 KUTUPLU DAĞITICI ÜNİTESİ (7x 12mm 125A)

Stok Kodu	Model	Fiyat TL	L	B	H	Koli Adeti
DU 125307	2+5 7 Delikli Dağıtım Ünitesi	504,00	88,00	130	55	12
DU 125310	2+8 10 Delikli Dağıtım Ünitesi	552,00	110,00	130	55	8
DU 125312	2+10 12 Delikli Dağıtım Ünitesi	600,00	125,00	130	55	8
DU 125315	2+13 15 Delikli Dağıtım Ünitesi	738,00	148,00	130	55	6
DU 125320	2+18 20 Delikli Dağıtım Ünitesi	924,00	185,00	130	55	4
DU 125322	2+20 22 Delikli Dağıtım Ünitesi	996,00	200,00	130	55	4

4 KUTUPLU DAĞITICI ÜNİTESİ (6,5x 9mm 80A)

Stok Kodu	Model	Fiyat TL	L	B	H	Koli Adeti
DU 80407	2+5 7 Delikli Dağıtım Ünitesi	468,00	60	80	75	10
DU 80410	2+8 10 Delikli Dağıtım Ünitesi	492,00	83	80	75	8
DU 80412	2+10 12 Delikli Dağıtım Ünitesi	564,00	92	80	75	6
DU 80415	2+13 15 Delikli Dağıtım Ünitesi	678,00	114	80	75	5
DU 80420	2+18 20 Delikli Dağıtım Ünitesi	852,00	154	80	75	4
DU 80422	2+20 22 Delikli Dağıtım Ünitesi	876,00	160	80	75	4
DU 80425	2+23 25 Delikli Dağıtım Ünitesi	996,00	198	80	75	4

4 KUTUPLU DAĞITICI ÜNİTESİ (7x 12mm 125A)

Stok Kodu	Model	Fiyat TL	L	B	H	Koli Adeti
DU 125407	2+5 7 Delikli Dağıtım Ünitesi	456,00	60	80	75	10
DU 125410	2+8 10 Delikli Dağıtım Ünitesi	504,00	83	80	75	8
DU 125412	2+10 12 Delikli Dağıtım Ünitesi	558,00	97	80	75	6
DU 125415	2+13 15 Delikli Dağıtım Ünitesi	684,00	120	80	75	5
DU 125420	2+18 20 Delikli Dağıtım Ünitesi	876,00	155	80	75	4
DU 125422	2+20 22 Delikli Dağıtım Ünitesi	948,00	170	80	75	4
DU 125425	2+23 25 Delikli Dağıtım Ünitesi	1.104,00	191	80	75	4

4 KUTUP 10x15 KESİT 160 AMP DAĞITICI ÜNİTELER

Stok Kodu	Model	Fiyat TL	L	B	H	Koli Adeti
DU 160407	2+5 7 Delikli Dağıtım Ünitesi	840,00	105	144	55	8
DU 160410	2+8 10 Delikli Dağıtım Ünitesi	1.200,00	145	144	55	8
DU 160412	2+10 12 Delikli Dağıtım Ünitesi	1.440,00	165	144	55	8
DU 160415	2+13 15 Delikli Dağıtım Ünitesi	1.800,00	200	144	55	8
DU 160420	2+18 20 Delikli Dağıtım Ünitesi	2.340,00	255	144	55	4
DU 160422	2+20 22 Delikli Dağıtım Ünitesi	2.795,00	275	144	55	4

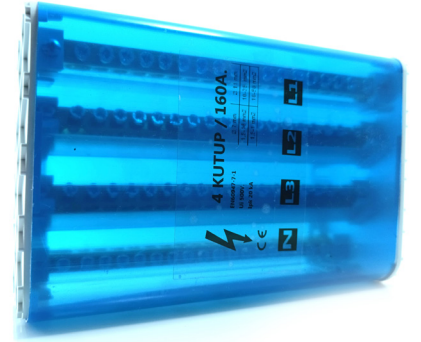

2 KUTUPLU DAĞITICI ÜNİTELER

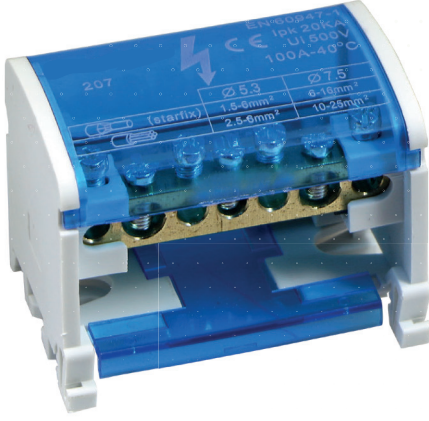

BİRİM FİYAT TL / AD	225,00	
SİPARİŞ KODU	4301	
ÜRÜN KODU	JD-2x7	
AKIM	125 Amper	
KABLO CİNSİ	Tek Damar	Çok Telli
	Giriş	Çıkış
KABLO KESİTİ (mm ²)	1 x 10 - 35 mm ²	1 x 10 - 25 mm ² 5 x 1,5 - 6 mm ²
	1 x 10 - 16 mm ²	1 x 6 - 16 mm ² 5 x 1,5 - 6 mm ²
Ambalaj Adet	Paket	Koli
	1	138

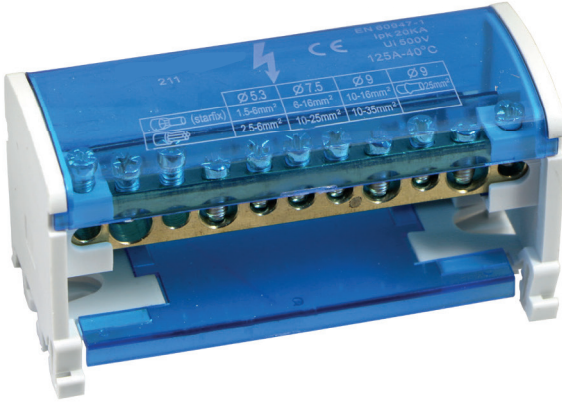

BİRİM FİYAT TL / AD	320,00	
SİPARİŞ KODU	4302	
ÜRÜN KODU	JD-2x11	
AKIM	125 Amper	
KABLO CİNSİ	Tek Damar	Çok Telli
	Giriş	Çıkış
KABLO KESİTİ (mm ²)	2 x 10 - 35 mm ²	2 x 10 - 25 mm ² 7 x 2,5 - 6 mm ²
	2 x 10 - 16 mm ²	2 x 6 - 16 mm ² 7 x 1,5 - 6 mm ²
Ambalaj Adet	Paket	Koli
	1	84

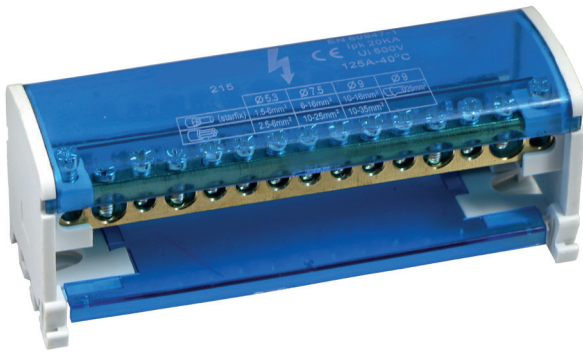

BİRİM FİYAT TL / AD	415,00	
SİPARİŞ KODU	4303	
ÜRÜN KODU	JD-2x15	
AKIM	125 Amper	
KABLO CİNSİ	Tek Damar	Çok Telli
	Giriş	Çıkış
KABLO KESİTİ (mm ²)	2 x 10 - 35 mm ²	2 x 10 - 25 mm ² 11 x 2,5 - 6 mm ²
	2 x 10 - 16 mm ²	2 x 6 - 16 mm ² 11 x 1,5 - 6 mm ²
Ambalaj Adet	Paket	Koli
	1	72

4 KUTUPLU DAĞITICI ÜNİTELER

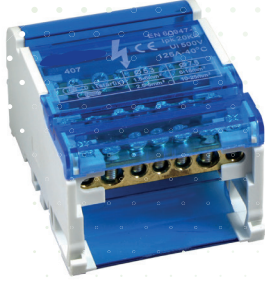

BİRİM FİYAT TL / AD	415,00	
SİPARİŞ KODU	4304	
ÜRÜN KODU	JD-4x7	
AKIM	125 Amper	
KABLO CİNSİ	Tek Damar	Çok Telli
	Giriş	Çıkış
KABLO KESİTİ (mm ²)	1 x 10 - 35 mm ²	1 x 10 - 25 mm ² 5 x 1,5 - 6 mm ²
	1 x 10 - 16 mm ²	1 x 6 - 16 mm ² 5 x 1,5 - 6 mm ²
Ambalaj Adet	Paket	Koli
	1	74

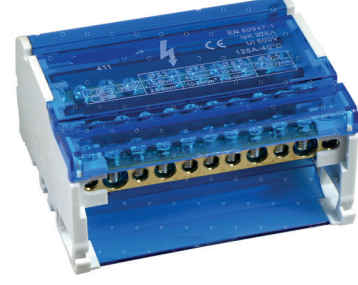

BİRİM FİYAT TL / AD	620,00	
SİPARİŞ KODU	4305	
ÜRÜN KODU	JD-4x11	
AKIM	125 Amper	
KABLO CİNSİ	Tek Damar	Çok Telli
	Giriş	Çıkış
KABLO KESİTİ (mm ²)	2 x 10 - 35 mm ²	2 x 10 - 25 mm ² 7 x 2,5 - 6 mm ²
	2 x 10 - 16 mm ²	2 x 6 - 16 mm ² 7 x 1,5 - 6 mm ²
Ambalaj Adet	Paket	Koli
	1	50



BİRİM FİYAT TL / AD	770,00	
SİPARİŞ KODU	4306	
ÜRÜN KODU	JD-4x15	
AKIM	125 Amper	
KABLO CİNSİ	Tek Damar	Çok Telli
	Giriş	Çıkış
KABLO KESİTİ (mm ²)	2 x 10 - 35 mm ²	2 x 10 - 25 mm ² 11 x 1,5 - 6 mm ²
	2 x 10 - 16 mm ²	2 x 6 - 16 mm ² 11 x 1,5 - 6 mm ²
Ambalaj Adet	Paket	Koli
	1	40

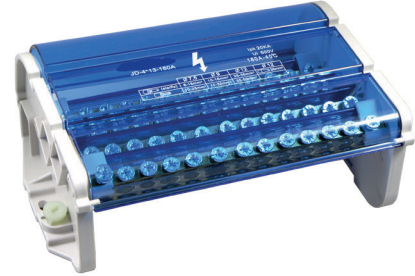

BİRİM FİYAT TL / AD	1.850,00	
SİPARİŞ KODU	4307	
ÜRÜN KODU	JD-4x12/160A	
AKIM	160 Amper	
KABLO CİNSİ	Tek Damar	Çok Telli
	Giriş	Çıkış
KABLO KESİTİ (mm ²)	1 x 10 - 50 mm ²	3 x 10 - 25 mm ² 8 x 1,5 - 6 mm ²
	1 x 10 - 50 mm ²	3 x 6 - 16 mm ² 8 x 1,5 - 6 mm ²
Ambalaj Adet	Paket	Koli
	1	18

BARALAR

BAKIR NÖTR TOPRAK EŞ POTANSİYEL BARALAR 250 AMPER 4×20 (İZOLATÖR AYAKLI)

Stok Kodu	Model	Fiyat TL	L	B	H	Koli Adeti
PWR 3608	1 Giriş 7 Çıkış	742,00	200	-	45	100
PWR 3611	1 Giriş 10 Çıkış	1097,00	260	-	45	75
PWR 3615	1 Giriş 14 Çıkış	1138,00	335	-	45	50

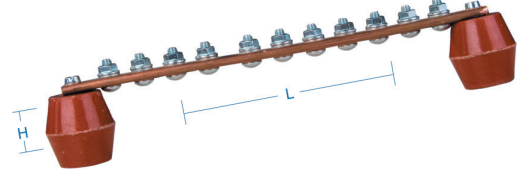

BAKIR NÖTR TOPRAK EŞ POTANSİYEL BARALAR 250 AMPER 4×20 (PLASTİK AYAKLI)

Stok Kodu	Model	Fiyat TL	L	B	H	Koli Adeti
PWR 3708	1 Giriş 7 Çıkış	660,00	220	40	39	100
PWR 3711	1 Giriş 10 Çıkış	825,00	270	40	39	75
PWR 3715	1 Giriş 14 Çıkış	1055,00	345	40	39	50

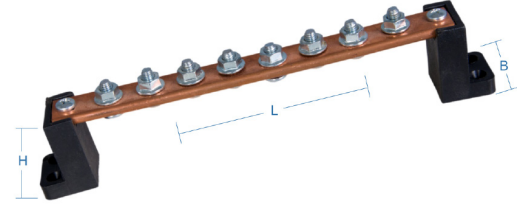

TRİFAZE MÜŞTEREK W OTOMAT BARASI

Stok Kodu	Ölçü	Fiyat TL	Akım (A)	Modül	Koli Adeti
PWR 31010	53 cm	383,00	63A (0,8 mm)	10	25
PWR 31510	53 cm	433,00	80A (1 mm)	10	25
PWR 31020	106 cm	765,00	63A (0,8 mm)	20	25
PWR 31520	106 cm	865,00	80A (1mm)	20	25

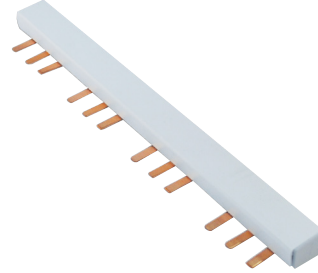

MONOFAZE MÜŞTEREK W OTOMAT BARASI

Stok Kodu	Ölçü	Fiyat TL	Akım (A)	Modül	Koli Adeti
PWR 11060	106 cm	375,00	80	60	50
PWR 11030	53 cm	188,00	80	30	50

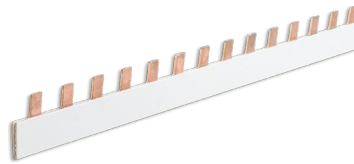

NÖTR TOPRAKLAMA BARASI

Stok Kodu	Ölçü	Fiyat TL	Akım (A)	Modül	Koli Adeti
PWRTB 1531	15×1,5	672,00	100 cm	31	40
PWRTB 1562	15×1,5	812,00	100 cm	62	40
PWRTB 2031	15×2,0	812,00	100 cm	31	40
PWRTB 2062	15×2,0	1230,00	100 cm	62	40



ORTA GERİLİM SİGORTALARI

Stok Kodu	Model	Fiyat TL	Değer	Ölçüler	Koli Adeti
PWR OGP 2	2A Pimli O.G. Sigorta	790,00	2A 36kV	537 mm	12
PWR OGP 6	6A Pimli O.G. Sigorta	790,00	6A 36kV	537 mm	12
PWR OGP 10	10A Pimli O.G. Sigorta	790,00	10A 36kV	537 mm	12
PWR OGP 16	16A Pimli O.G. Sigorta	790,00	16A 36kV	537 mm	12
PWR OGP 20	20A Pimli O.G. Sigorta	790,00	20A 36kV	537 mm	12
PWR OGP 25	25A Pimli O.G. Sigorta	790,00	25A 36kV	537 mm	12
PWR OGP 30	30A Pimli O.G. Sigorta	790,00	30A 36kV	537 mm	12
PWR OGP 40	40A Pimli O.G. Sigorta	790,00	40A 36kV	537 mm	12
PWR OGP 50	50A Pimli O.G. Sigorta	1150,00	50A 36kV	537 mm	6
PWR OGP 63	63A Pimli O.G. Sigorta	1150,00	63A 36kV	537 mm	6
PWR OGP 80	80A Pimli O.G. Sigorta	1150,00	80A 36kV	537 mm	6
PWR OGP 100	100A Pimli O.G. Sigorta	1150,00	100A 36kV	537 mm	6
PWR OGP 125	125A Pimli O.G. Sigorta	1150,00	125A 36kV	537 mm	6



KAPLAMA ÇUBUK

Stok Kodu	Model	Fiyat TL	Mikron	Koli Adeti
PWR BK 161	1mt Kaplama Bakır Çubuk Q16	☎	250	1
PWR BK 1615	1,5 mt Kaplama Bakır Çubuk Q16	☎	250	1
PWR BK 201	1mt Kaplama Bakır Çubuk Q20	☎	250	1
PWR BK 2015	1,5 mt Kaplama Bakır Çubuk Q20	☎	250	1



DÖKÜM LEVHALAR

Stok Kodu	Model	Fiyat TL	Koli Adeti
PWR OG 028	Tedaş Asfalt Döküm Plakası AG-OG	☎	1
PWR OG 0281	Tedaş Asfalt Döküm Plakası OG	☎	1
PWR OG 0282	Tedaş Asfalt Döküm Plakası AG	☎	1



ÖLÜM TEHLİKESİ LEVHALARI

Stok Kodu	Model	Fiyat TL	Koli Adeti
PWR OG 027	15 x 23cm Ölüm Tehlikesi Levhası	☎	250
PWR OG 0271	15 x 10cm Ölüm Tehlikesi Levhası	☎	250
PWR OG 0272	7 x 5cm Ölüm Tehlikesi Levhası	☎	100



TSE TİP BRANŞMAN (PARALEL- ATLAMA) ALÜMİNYUM KLEMENS

Stok Kodu	Model	Fiyat TL	Sıkma Sahası	Kullanıldığı İletkenler	Koli Adeti
PWR BK 2525	A25-A25	27,00	6-25	Rose	500
PWR BK 4040	A40-A40	36,60	16-40	Rose, Lily, Swallow, Sparrow	500
PWR BK 7070	A70-A70	58,00	16-70	Lily, Pansy, Swallow, Aster, Rawen	250
PWR BK 120120	A120-A120	96,84	40-120	Pansy, Aster, Phlox, Oxlip, Rawen, Pigeon	125
PWR BK 240240	A240-A240	264,00	70-240	Daisy, Peony, Tulip, Canna, Patridge, Ostrich, Hawk	40

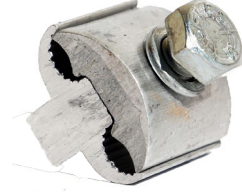

TSE TİP BİMETAL (AL-CU) ALÜMİNYUM KLEMENS

Stok Kodu	Model	Fiyat TL	Sıkma Sahası	Kullanıldığı İletkenler	Kutu Adeti
PWR BK 2516	A25-B16	41,75	6-25AL/2,5-16CU	Rose	500
PWR BK 4025	A40-B25	53,00	16-40AL/10-25CU	Rose, Lily, Swallow, Sparrow	500
PWR BK 7050	A70-B50	87,15	16-70AL/10-50CU	Rose, Lily, Swallow, Sparrow	250
PWR BK 240120	A240-B120	314,88	70-240AL/70-240CU	Daisy, Peony, Tulip, Canna, Patridge, Ostrich	40

EKONOMİK TİP BRANŞMAN (PARALEL- ATLAMA) ALÜMİNYUM KLEMENS TSE'SİZ

Stok Kodu	Model	Fiyat TL	Sıkma Sahası	Kullanıldığı İletkenler	Kutu Adeti
PWR EBK 2525	A25-A25	26,00	6-25	Rose	500
PWR EBK 4040	A40-A40	21,84	16-40	Rose, Lily, Swallow, Sparrow	500
PWR EBK 7070	A70-A70	35,40	16-70	Rose, Lily, Swallow, Sparrow, Pansy	250
PWR EBK 120120	A120-A120	64,20	40-120	Pansy, Aster, Phlox, Oxlip, Rawen, Pigeon	125
PWR EBK 240240	A240-A240	186,00	70-240	Daisy, Peony, Tulip, Canna, Patridge, Ostrich, Hawk	40



EKONOMİK TİP BRANŞMAN (AL- CU) ALÜMİNYUM KLEMENS TSE'SİZ

Stok Kodu	Model	Fiyat TL	Sıkma Sahası	Kullanıldığı İletkenler	Kutu Adeti
PWR EBK 2516	A25-B16	23,16	6-25AL/2,5-16CU	Rose	500
PWR EBK 4025	A40-B25	30,00	16-40AL/10-25CU	Rose, Lily, Swallow, Sparrow	500
PWR EBK 7050	A70-B50	43,44	16-70AL/10-50CU	Rose, Lily, Swallow, Sparrow	250
PWR EBK 240120	A240-B120	218,10	70-240AL/50-120CU	Daisy, Peony, Tulip, Canna, Patridge, Ostrich	40





VHD KAPAMA



BORU TİPİ
İZOLASYON



OG BUŞING
KAPAMA



SİLİKON PARAFUR
İZOLASYON



AG BUŞING KAPAMA
250A



AG BUŞING KAPAMA
630 A



AG BUŞING KAPAMA
1000 A



AG BUŞING KAPAMA
2000 A

Stok Kodu	Model	Fiyat TL
SMF- 1001	AG Buşing İzolasyon Kapağı - 250A (50- 160 kVA)	180,00
SMF- 1002	AG Buşing İzolasyon Kapağı - 630A (200- 400 kVA)	198,00
SMF- 1003	AG Buşing İzolasyon Kapağı - 1000A (500 - 630 kVA)	216,00
SMF- 1004	AG Buşing İzolasyon Kapağı - 2000A (800 - 2000 kVA)	243,00
SMF- 1005	OG Buşing İzolasyon Kapağı	315,00
SMF- 1006	VHD İzolasyon Kapağı	324,00
SMF- 1007	OG Boru Tipi İletken Kapama (Q8, Swallow, Raven)	72,00
SMF- 1008	Parafudr İzolasyon Kapağı (Silikon Parafudr)	180,00

Ürünlerimiz özel yapılmış soğuk uygulamalı izolasyon kapamalarımız kuş, yabani hayvan ve hattın ormanlık alan geçişlerinde uzayan ağaç dallarının temalarının sebep olduğu elektrik kesintilerine ve arızalara engel olmakla beraber elektrik şebekelerinin de kuş ve yabani hayvanlara zarar vermesini engeller. Ayrıca can güvenliği açısından koruma sağlar.

- Halogen free yapıdadır.
- Ürünler homojen yapıdadır ve her noktasında et kalınlığı aynıdır. (Köşelerde ve geçiş noktalarında inceleme yoktur. Bu durumda zayıf nokta

oluşmayacağından mükemmel izolasyon sağlar.)

- Hidrofobik yüzeye sahiptir, su yolu oluşturmaz.
- Uzun ömürlüdür ve UV ışınlarına karşı yüksek dirençlidir.
- Üstün mekanik dayanıma sahiptir.
- Üstün elektriksel izolasyon sağlar.
- V0 yanmazlık özelliğine sahiptir.
- Yüksek sıcaklık dayanımı vardır.
- Raf ömrü uzundur.
- Uygulaması pratik ve kolaydır.



Ufo S Aktif
Paratoner



Direk İniş
Kroşesi

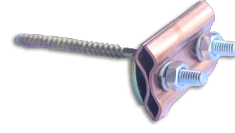

Duvar Kroşesi

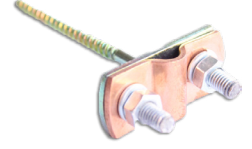

Duvar Kroşesi

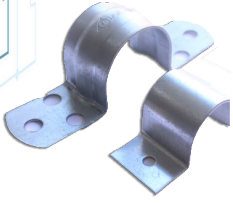

Boru Kelepçesi

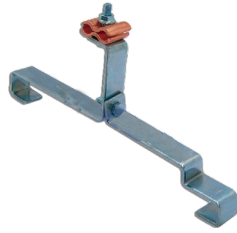

Kiremit Kroşe

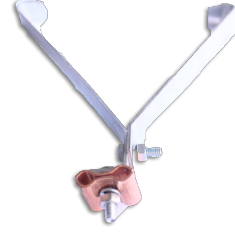

Mahya Kroşe

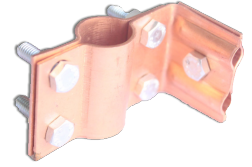

L Tipi Elektrod
Başlığı



U Branşman



Şerit Ek
Elemanları

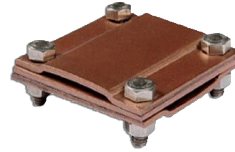

Ek Mufu Kare
Tip Bakır
Dağıtım
Klemensleri



Gergi Kelepçesi



Pirinç Elektrod
Başlığı

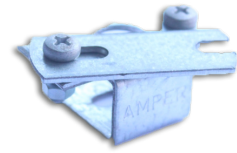

30x 3 U Tipi
Duvar Kroşe



U Tipi Duvar
Kroşe 1x 50 Bakır



Elektrod
Başlıkları 1x 50



U Bolt Saplama

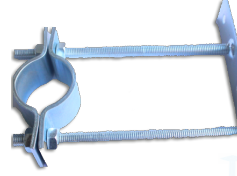

Duvar Tipi Boru
Kelepçesi

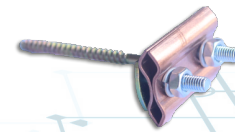

Duvar Kroşesi

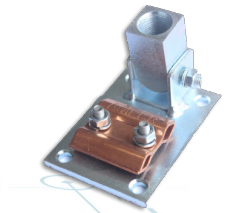

Yakalama Ucu
Altlığı Düz Tip

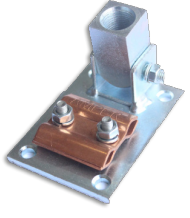

Yakalama Ucu
Altlığı Oynar Tip



CR-Nİ Kaplı
Yakalama Uçları

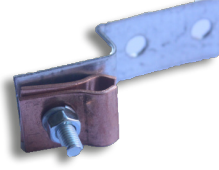

Z Tipi Duvar
Kroşe 1x50



Pirinç Test
Klemensi 1x50



Pirinç İstavroz

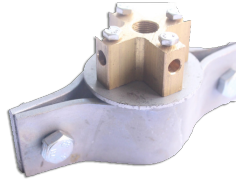

Boru Tipi
Yakalama Ucu
Altlığı



SKP Kablo
Pabuçları



Paralel Ek
Klemensi

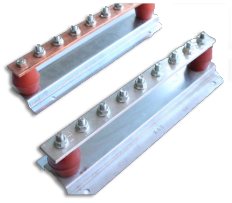

Eş Potansiyel
Denge Barası



Uçak İkaz
Lambası



Plastik Takoz



Termo Kaynak
Tozları

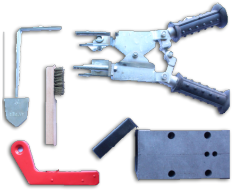

Termo Kaynak
Ekipmanları



Plastik Topraklama
Rögarı



Galvanizli Şerit



Antistatik
Topraklama
Levhası

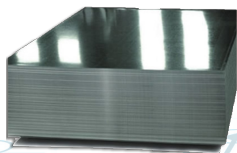

Galvanizli Levha



Toprak Direnç
Düşürücü
Malzeme



Galvanizli
Topraklama
Köşebentleri

OG HIRDAVAT ÜRÜNLERİ VE YARDIMCI EKİPMANLARI



K-1 / K-2 Tek Askı Tertibatı
(Beton ve Demir Direkler için)



K-1 / K-2 Tek Gergi Tertibatı
(Beton ve Demir Direkler için)



K-1 / K-2 Çift Askı Tertibatı
(Beton ve Demir Direkler için)



K-1 / K-2 Çift Gergi Tertibatı
(Beton ve Demir Direkler için)



İzolatör Demirleri
(B/O - B/Y - D/T)

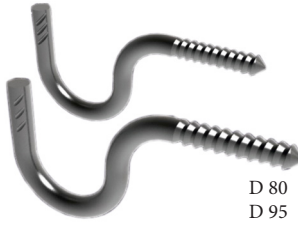

Deveboynu İzolatör Demirleri



Alpek Askı Takımı
(AK 100 Askı Kancası 5/8- ÖD.85 Özengi Demiri
1M.22 İzolatör Mili)



S-1 Boru
(1.20mm- 50cm)
Ezme Boru
(1.50- 30cm/2.00mm- 30cm)

Armatür Boruları
(Ağaç, Beton ve Demir Direkler İçin)

ORTA GERİLİM ÜRÜNLERİ HÜCRE- KÖŞK- TRAFO- AYIRICI



Mesnet İzolatörler



K1 - K2 - K3 Porselen(Zincir)
Tip İzolatörler



Kompozit Silikon İzolatörler



OG Polimer Parafudrlar



Buşing ve İzolatör Kapamaları



Harici - Dahili Tip OG Ayırıcılar



Hermetik Tip ve Genleşme
Depolu Trafolar

İZOLE HALILAR

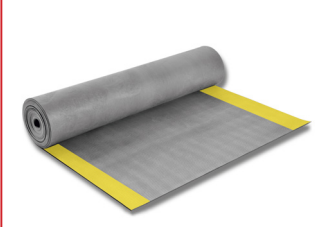

10.000V İzole Halı
Kalınlık: 2mm
(TS EN 60243-1
TS EN 61111 Madde)
5. 6. 4. 3'e göre üretilmektedir.

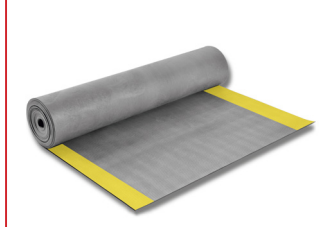

20.000V İzole Halı
Kalınlık: 3mm
(TS EN 60243-1
TS EN 61111 Madde)
5. 6. 4. 3'e göre üretilmektedir.

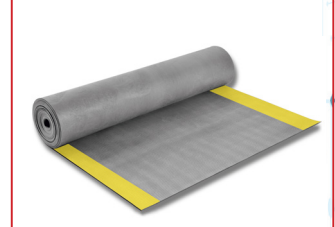

36.000V
Kalınlık: 4mm
İzole Halı (TS EN 60243-1
TS EN 61111 Madde)
5. 6. 4. 3'e göre üretilmektedir.

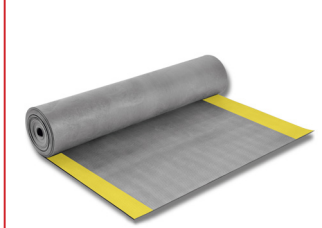

40.000V İzole Halı
Kalınlık: 5mm
(TS EN 60243-1
TS EN 61111 Madde)
5. 6. 4. 3'e göre üretilmektedir.

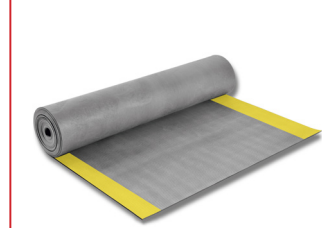

İkaz Şeritli İzole Halılar
Kalınlık: 2mm, 3mm, 4mm, 5mm
(TS EN 60243-1
TS EN 61111 Madde)
5. 6. 4. 3'e göre üretilmektedir.

AG-OG PANOLARI VE ŞALT OTOMASYON ÜRÜNLERİ



Dikili Tip Modüler Panolar

İZOLE İŞ GÜVENLİĞİ EKİPMANLARI



36Kv İzole Sehpa



36Kv Sesli Işıklı Gerilim
Dedektörü



İzole Çizme ve Eldiven
(EN 20345 - EN 50321
IEC 60903 - EN 60903)



www.uespower.com.tr